

HRT/4-560/25 BPN

IP54



Dimensiones y conexiones

Dimensions and wiring

Características

Characteristics

Tensión Voltage	3 ~ 400V 50Hz
Tipo motor Motor type	4 polos 4 poles IP54 cl.F
Potencia absorbida máxima Maximum power absorbed	1,07/0,73 kW
Intensidad absorbida máxima Maximum absorbed current	2,1/1,3 A
Condensador Capacitor	
Ia/In Is/In	3,0
Temperatura del aire Air temperature	-40°C < T < +70°C
Peso Weight	15,4 kg
Código ventilador Fan code number	5700194300
Código motor Motor code number	0342402005

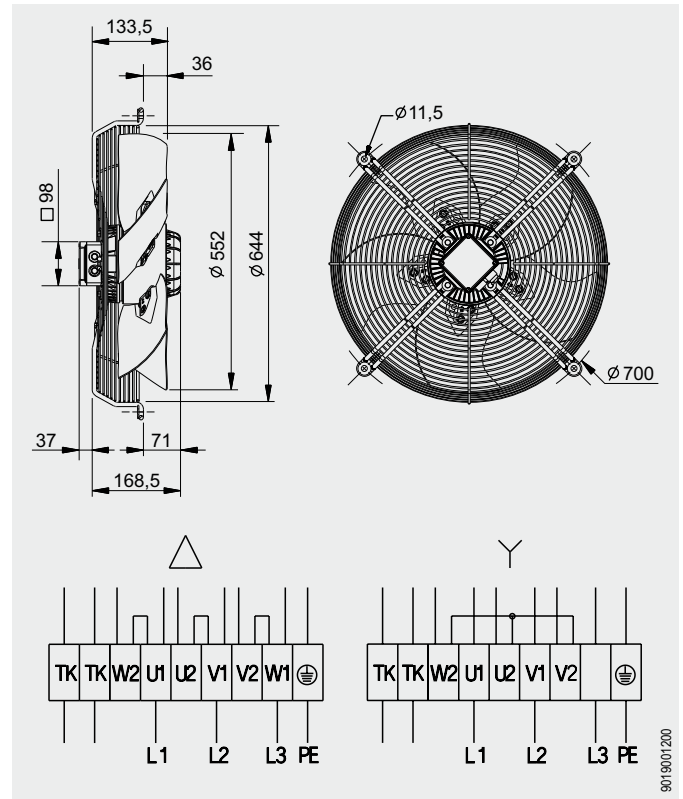

Curvas características / Performance curves (04/02/2012)

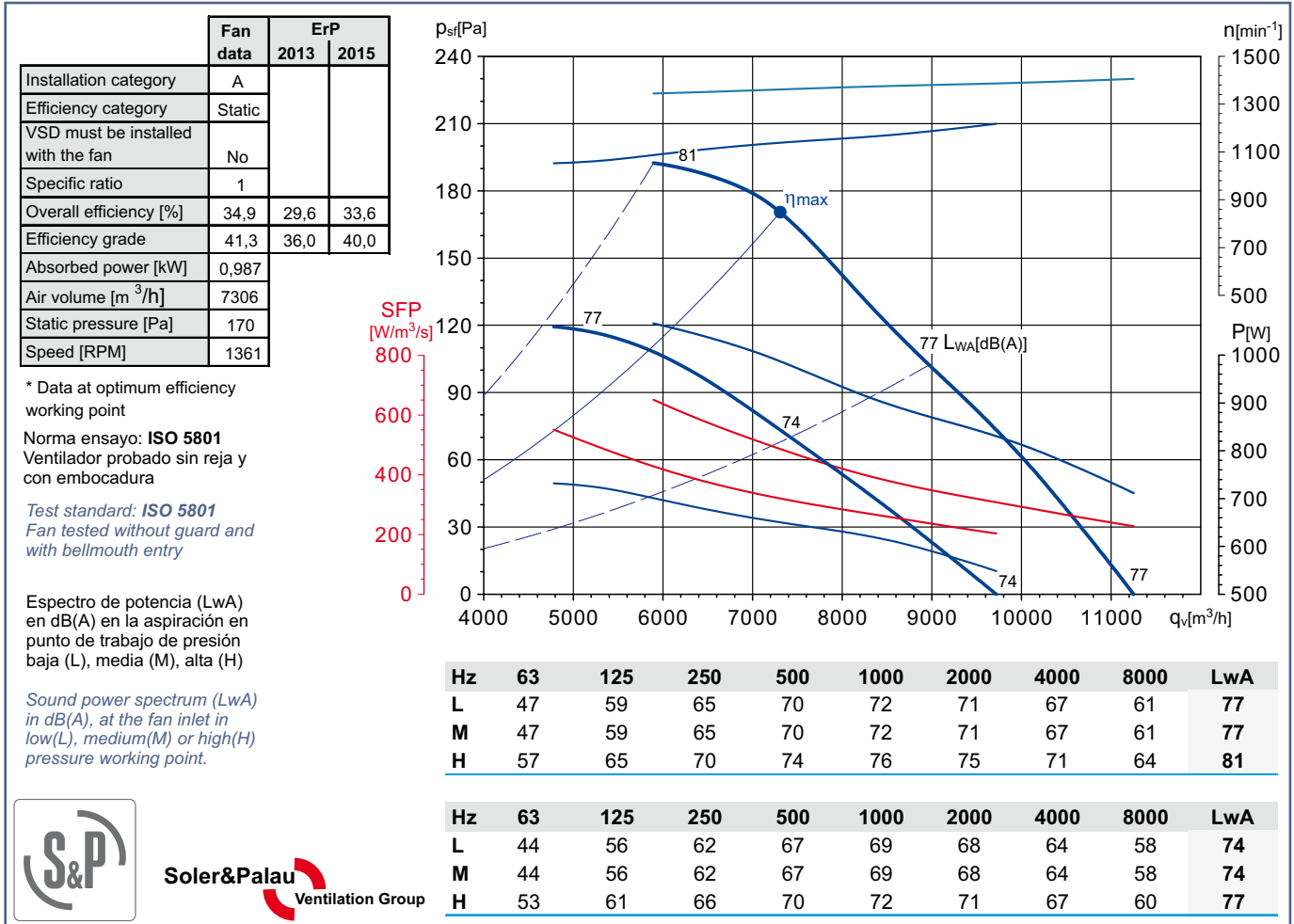

Soler&Palau
Ventilation Group