

HRT/6-630/25 BPN

IP54



Dimensiones y conexiones Dimensions and wiring

Características Characteristics

Tensión Voltage	3 ~ 400V 50Hz
Tipo motor Motor type	6 polos 6 poles IP54 cl.F
Potencia absorbida máxima Maximum power absorbed	0,51/0,32 kW
Intensidad absorbida máxima Maximum absorbed current	0,9/0,5 A
Condensador Capacitor	
Ia/In Is/In	3,1
Temperatura del aire Air temperature	-40°C < T < +70°C
Peso Weight	16,5 kg
Código ventilador Fan code number	5700197600
Código motor Motor code number	0342701000

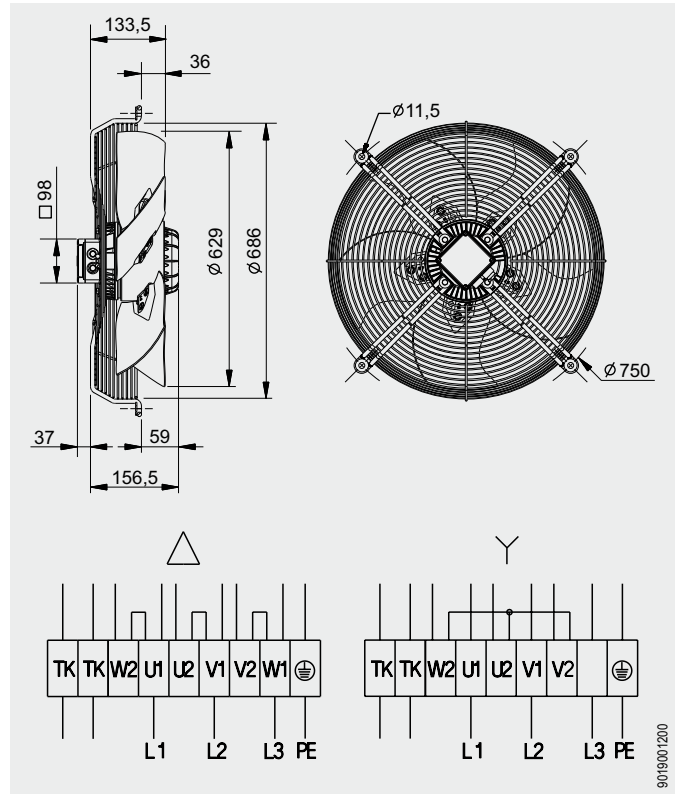

Curvas características / Performance curves (09/05/2012)

	Fan data	ErP	
		2013	2015
Installation category	A		
Efficiency category	Static		
VSD must be installed with the fan	No		
Specific ratio	1		
Overall efficiency [%]	33,2	27,6	31,6
Efficiency grade	41,6	36,0	40,0
Absorbed power [kW]	0,463		
Air volume [m ³ /h]	7364		
Static pressure [Pa]	75		
Speed [RPM]	866		

* Data at optimum efficiency working point

Norma ensayo: **ISO 5801**
Ventilador probado sin reja y con embocadura

Test standard: **ISO 5801**
Fan tested without guard and with bellmouth entry

Espectro de potencia (LwA) en dB(A) en la aspiración en punto de trabajo de presión baja (L), media (M), alta (H)

Sound power spectrum (LwA) in dB(A), at the fan inlet in low(L), medium(M) or high(H) pressure working point.

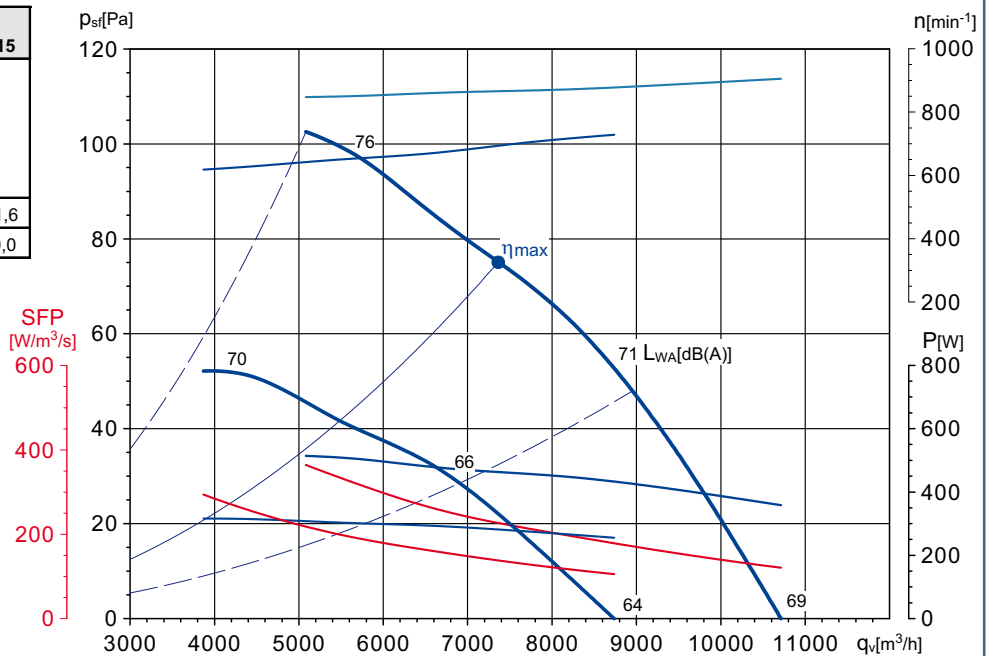

Hz	63	125	250	500	1000	2000	4000	8000	LwA
L	48	53	58	62	64	63	57	51	69
M	50	55	60	64	66	65	59	53	71
H	56	63	67	69	71	69	65	58	76

Hz	63	125	250	500	1000	2000	4000	8000	LwA
L	43	48	53	57	59	58	52	46	64
M	45	50	55	59	61	60	54	48	66
H	50	57	61	63	65	63	59	52	70



Soler&Palau
Ventilation Group