

HRT/6-710/30 BPN

IP54



Dimensiones y conexiones

Dimensions and wiring

Características

Characteristics

Tensión Voltage	3 ~ 400V 50Hz
Tipo motor Motor type	6 polos 6 poles IP54 cl.F
Potencia absorbida máxima Maximum power absorbed	1,13/0,78 kW
Intensidad absorbida máxima Maximum absorbed current	2,3/1,3 A
Condensador Capacitor	
Ia/In Is/In	3,3
Temperatura del aire Air temperature	-40°C < T < +50°C
Peso Weight	22,0 kg
Código ventilador Fan code number	5700345100
Código motor Motor code number	0344572003

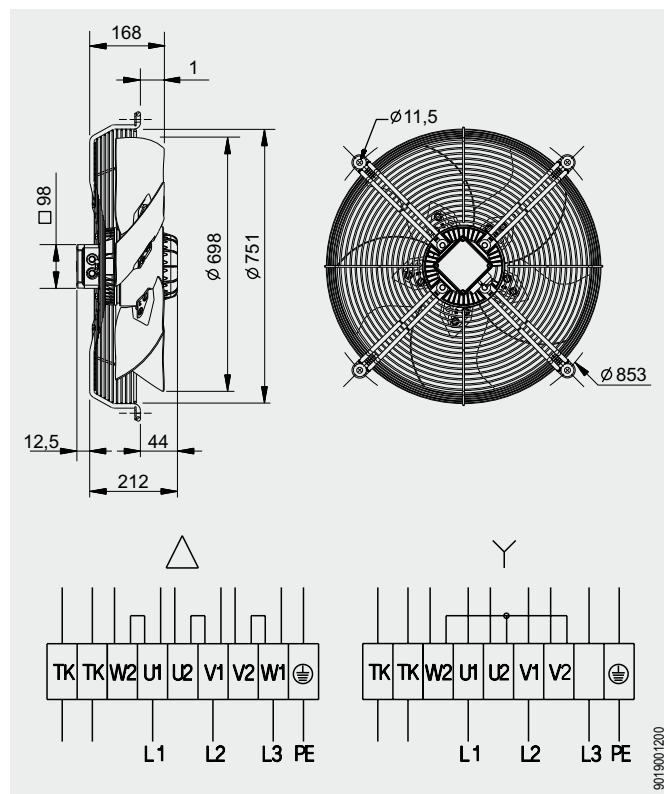

Curvas características / Performance curves (04/04/2012)

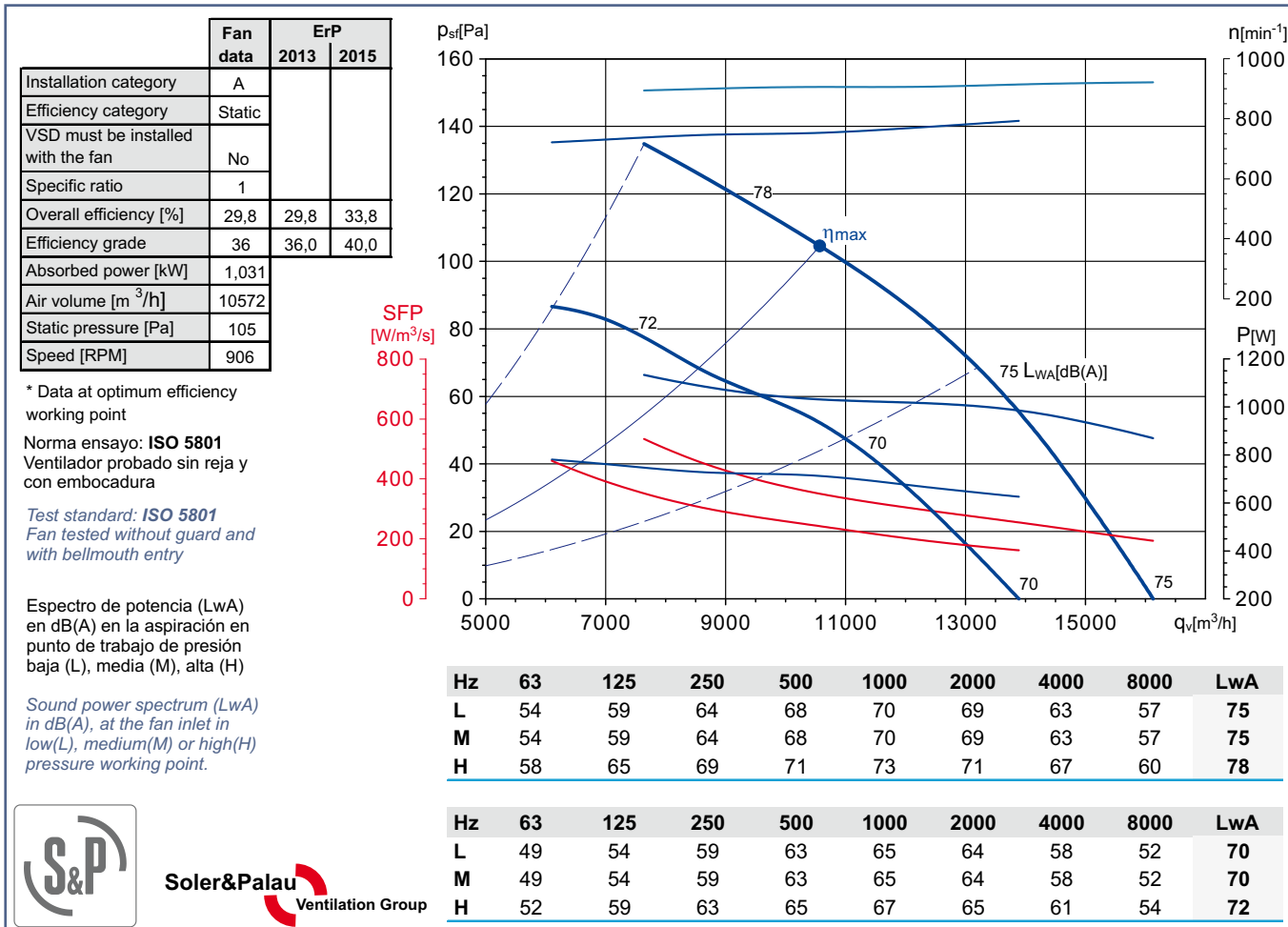

Soler&Palau
Ventilation Group