

HRST/6-710/28 BZ

IP54



Dimensiones y conexiones

Dimensions and wiring

Características

Characteristics

Tensión Voltage	3 ~ 400V 50Hz
Tipo motor Motor type	6 polos 6 poles IP54 cl.F
Potencia absorbida máxima Maximum power absorbed	1,25/0,97 kW
Intensidad absorbida máxima Maximum absorbed current	3,0/1,7 A
Condensador Capacitor	
Ia/In Is/In	3,5
Temperatura del aire Air temperature	-40°C < T < +65°C
Peso Weight	43,0 kg
Código ventilador Fan code number	5720064800
Código motor Motor code number	9024012523

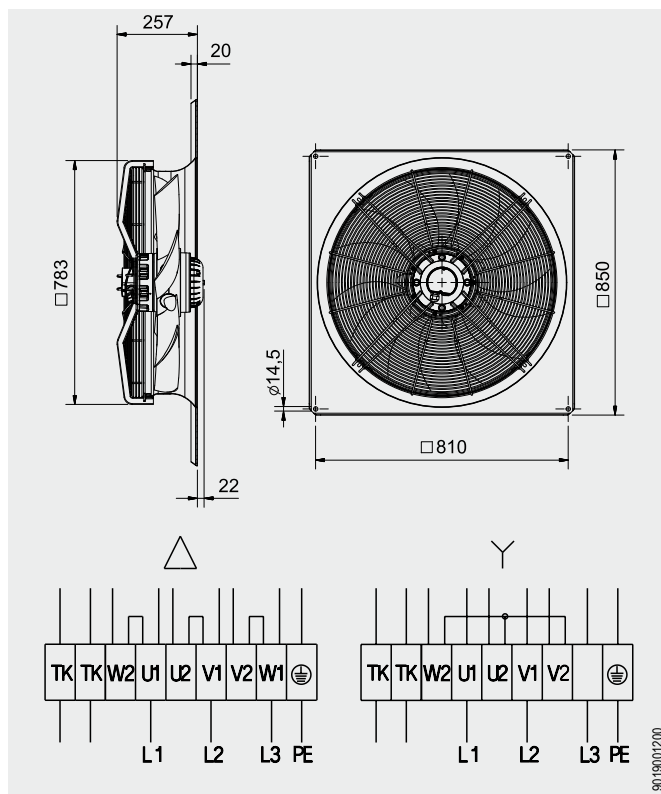

Curvas características / Performance curves (23/11/2012)

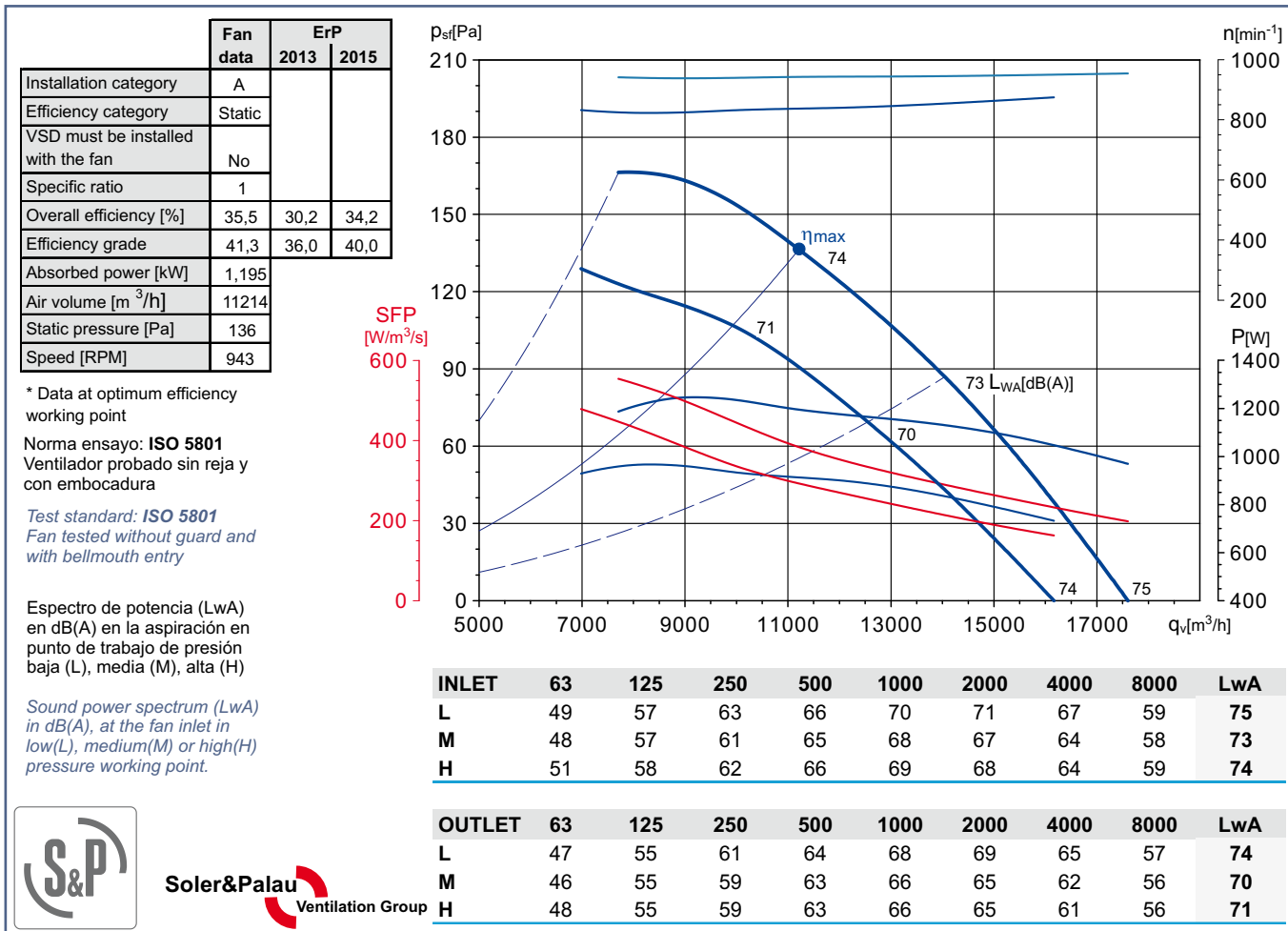

Soler&Palau
Ventilation Group