

Product drawing

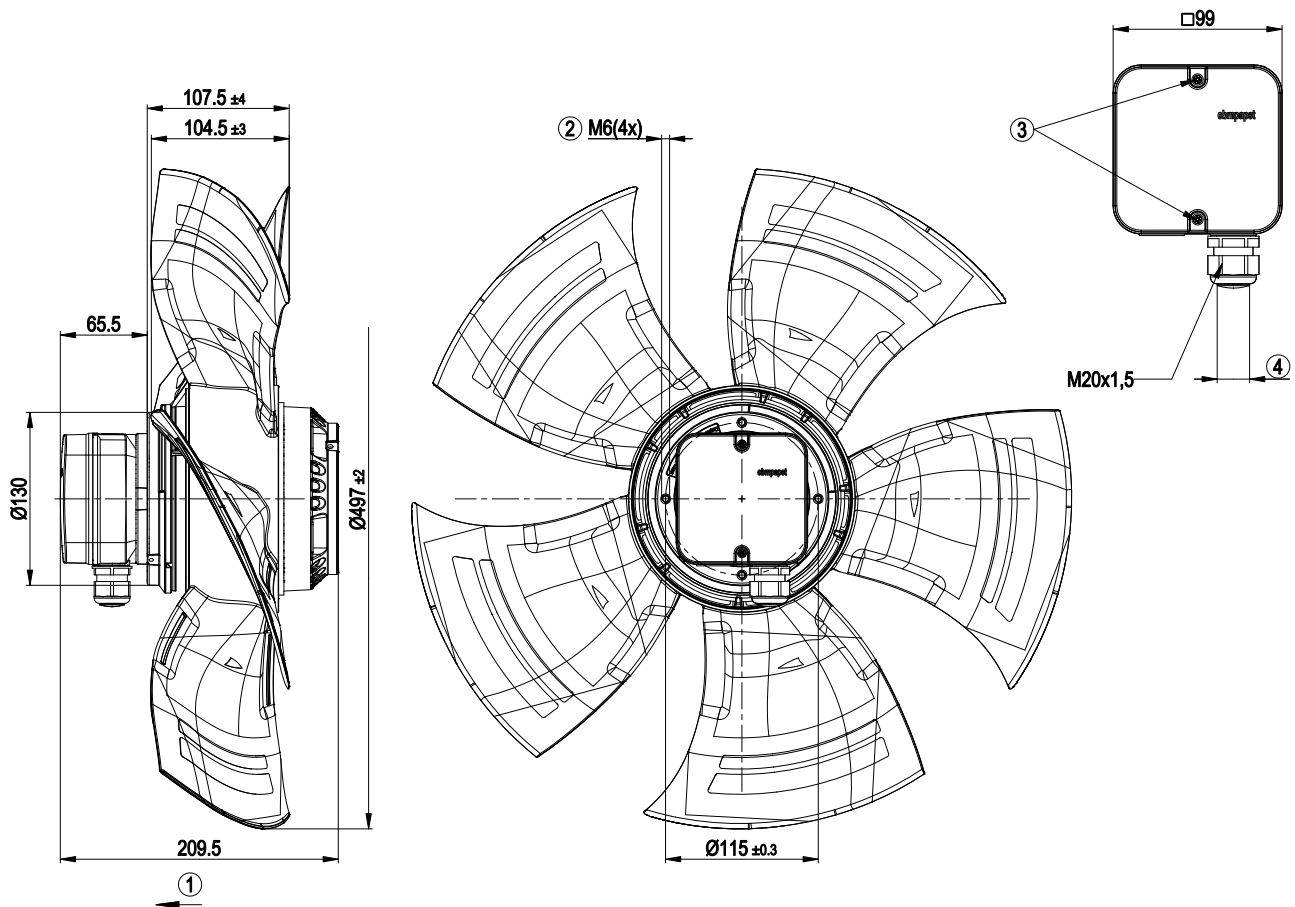

1	Direction of air flow "V"
2	Depth of screw max. 12 mm
3	Tightening torque 1.5±0.2 Nm
4	Cable diameter: min. 6 mm, max. 12 mm, tightening torque: 2±0.3 Nm