

Product drawing

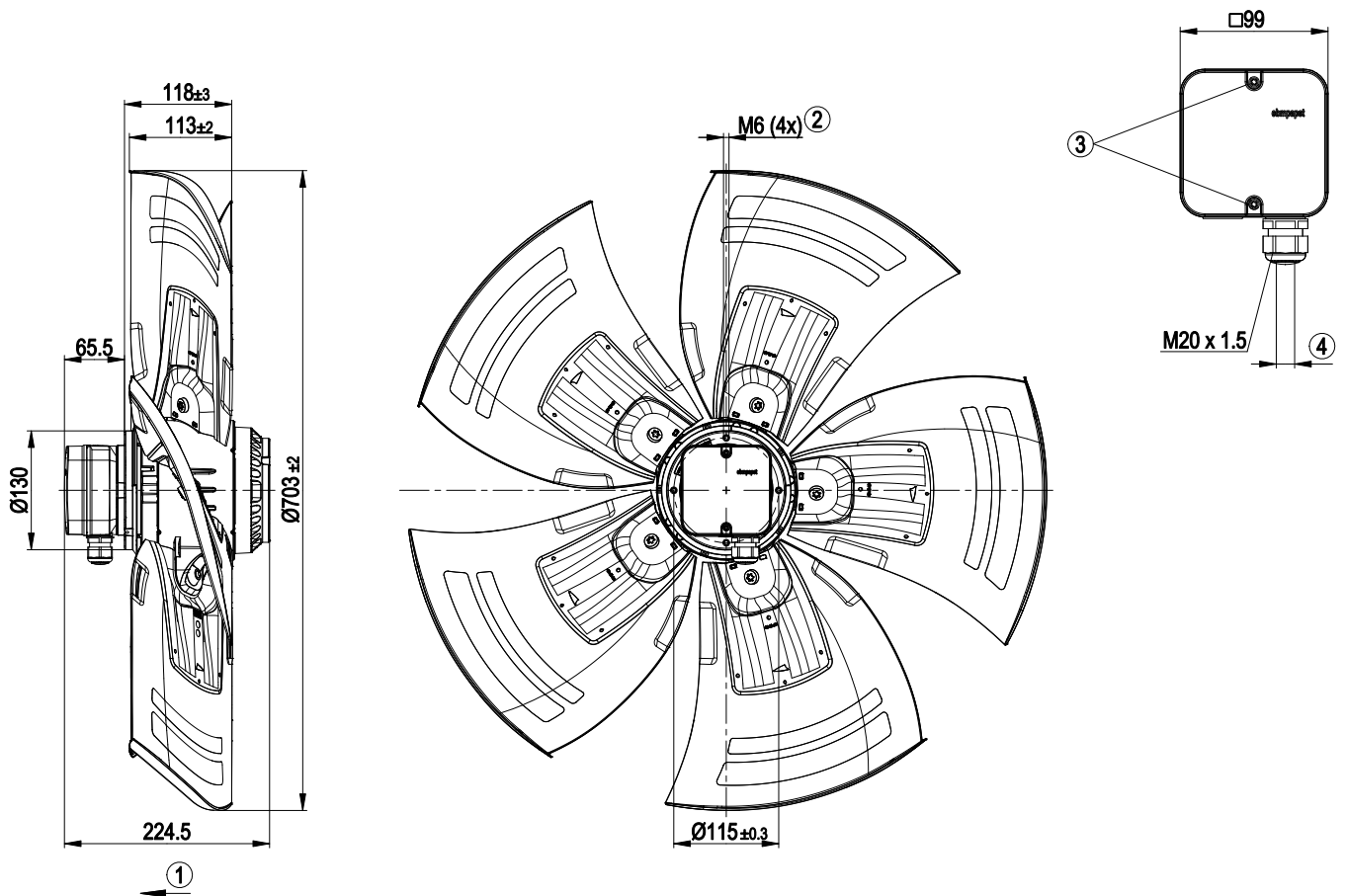

1	Direction of air flow "V"
2	Screw depth max. 12 mm
3	Tightening torque 1.5 ± 0.2 Nm
4	Cable diameter: min. 7 mm, max. 14 mm; tightening torque: 2 ± 0.3 Nm