

800 mm Ø

8 POLES/POLOS



Characteristics / Características

8-800/26 3~ 400V 50Hz

Is/In= 3,6

Type / Tipo	Curve / Curva	Voltage / Tensión (V)	Point / Punto	I (A)	P (W)	N (rpm)	LwA (dB (A))	Tmax. (°C)
HRBT/8-800/26	1	400Δ	L	1,18	490	695	76	
	1	400Δ	M	1,34	570	680	74	
	1	400Δ	H	1,40	580	685	77	60
	2	400Y	L	0,91	380	590	72	
	2	400Y	M	0,96	420	560	70	
	2	400Y	H	1,02	410	570	74	

Dimensions and Construction / Dimensiones y Construcción

Airflow B ←

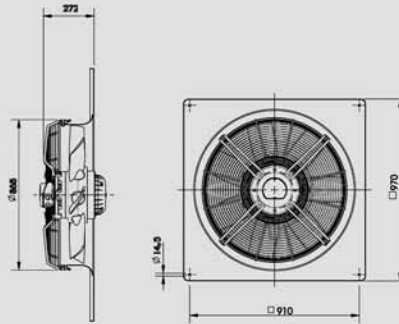
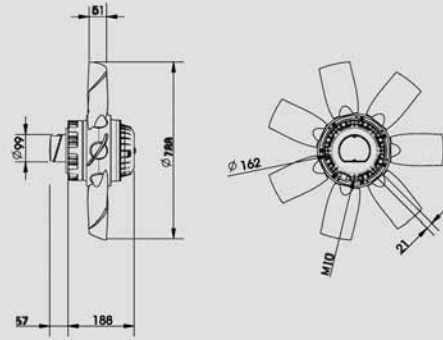

Weight/Peso (Kg)

Type / Tipo	S	PN	Q	Z
HRBT/8-800/26	30	40	48	48