

# AC axial fan - HyBlade®

sickled blades (S series)

with guard grille for short nozzle

## Product drawing

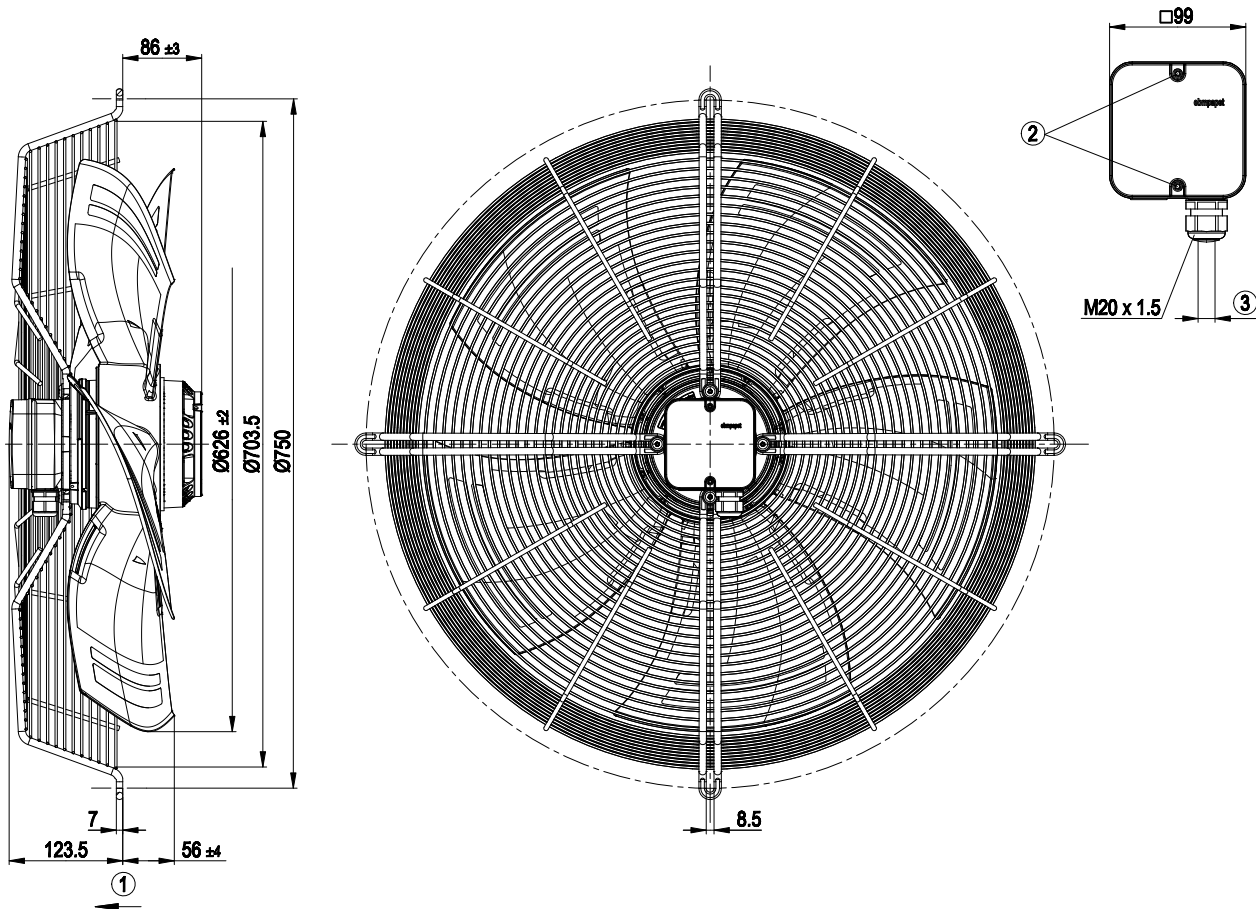

1	Direction of air flow "V"
2	Tightening torque 1.5±0.2 Nm
3	Cable diameter: min. 6 mm, max. 12 mm; tightening torque: 2±0.3 Nm

