

AC axial fan - HyBlade®

sickled blades (S series)

with full square nozzle

Product drawing

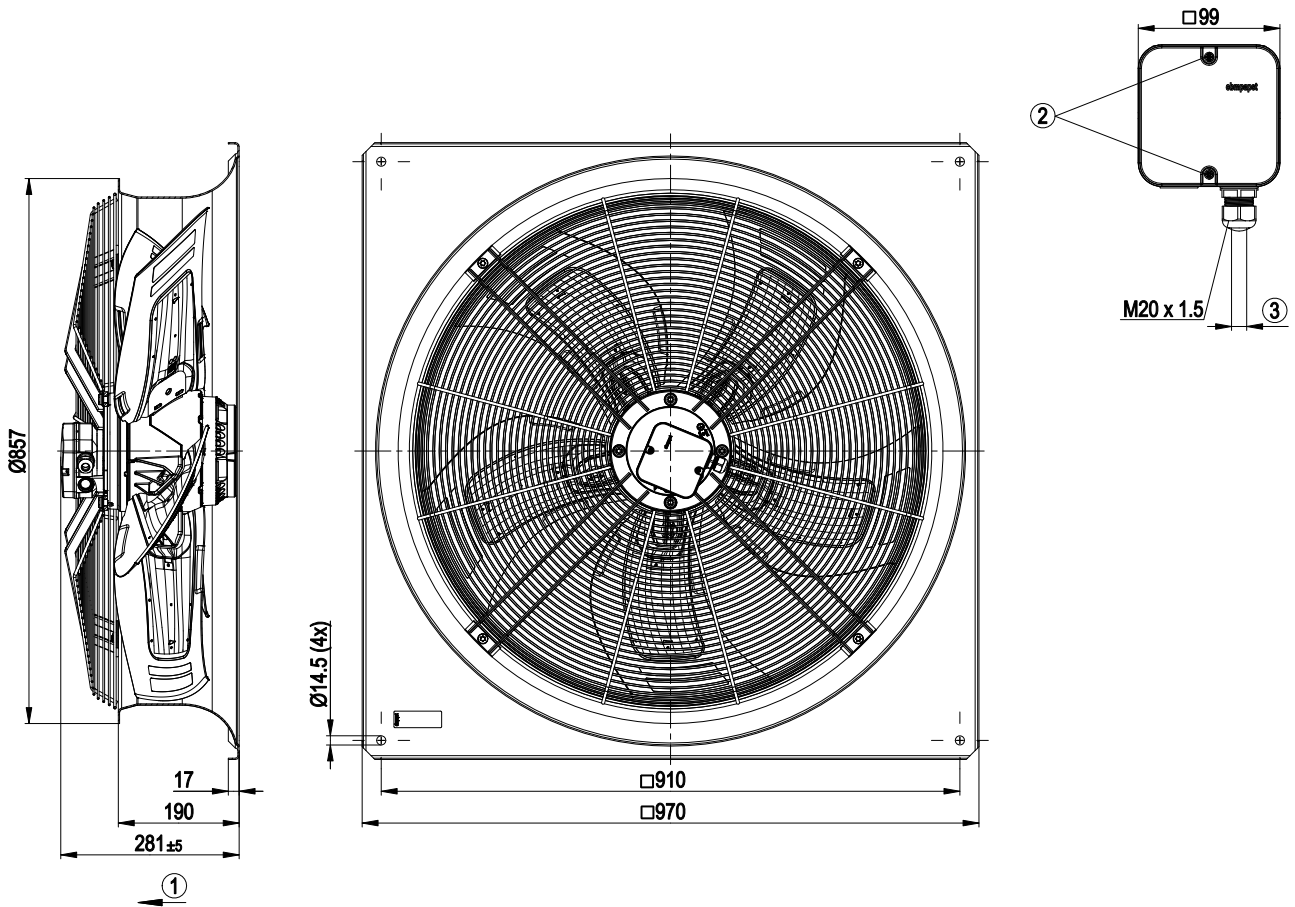

1	Direction of air flow "V"
2	Tightening torque 1.5 ± 0.2 Nm
3	Cable diameter: min. 7 mm, max. 14 mm, tightening torque: 2 ± 0.3 Nm

