



Electronic Controller for Compressor Racks

XC440C - XC440D

Instructions Manual



INDEX

1.	GENERAL WARNING	4
1.1	 PLEASE READ BEFORE USING THIS MANUAL	4
1.2	 SAFETY PRECAUTIONS	4
2.	GENERAL DESCRIPTION	4
3.	FIRST INSTALLATION	5
3.1	HOW TO SET THE KIND OF GAS	5
3.2	HOW TO SET THE RANGE OF THE PRESSURE PROBES	5
3.3	HOW TO SET THE KIND OF DISPLAY: RELATIVE OR ABSOLUTE PRESSURE	6
4.	USER INTERFACE	6
4.1	DISPLAYING	6
4.2	KEYBOARD	6
4.3	THE ICONS	7
5.	HOW TO SEE AND MODIFY THE SET POINT	7
5.1	HOW TO SEE THE SET POINT OF COMPRESSORS OR FANS	7
5.2	HOW TO MODIFY THE SET POINT OF COMPRESSORS OR FANS	8
6.	PARAMETERS PROGRAMMING	8
6.1	HOW TO ENTER THE "Pr1" PARAMETER LIST	8
6.2	HOW TO ENTER IN PARAMETERS LIST "Pr2"	8
6.3	HOW TO CHANGE PARAMETER VALUES	8
7.	HOW TO DISABLED AN OUTPUT	9
7.1	HOW TO DISABLED AN OUTPUT DURING A MAINTENANCE SESSION.	9
7.2	OUTPUT DISABLED SIGNALLING.	9
7.3	REGULATION WITH SOME OUTPUTS DISABLED.	9
8.	RUNNING HOURS OF LOADS	9
8.1	HOW TO DISPLAY THE RUNNING HOURS OF A LOAD.	9
8.2	HOW TO RESET THE RUNNING HOURS OF A LOAD.	9
9.	ALARM MENU	10
9.1	HOW TO SEE THE ALARMS	10
10.	USE OF THE PROGRAMMING "HOT KEY "	10
10.1	HOW TO PROGRAM A HOT KEY FROM THE INSTRUMENT (UPLOAD)	10
10.2	HOW TO PROGRAM AN INSTRUMENT USING A HOT KEY (DOWNLOAD)	10
11.	KEYBOARD LOCKING	11
11.1	HOW TO LOCK THE KEYBOARD	11
11.2	TO UNLOCK THE KEYBOARD	11

12.	LIST OF PARAMETERS	11
12.1	PLANT DIMENSIONING AND TYPE OF REGULATION.	11
12.2	PROBES CONFIGURATION	12
12.3	OTHERS INPUTS CONFIGURATION	12
12.4	DISPLAY AND MEASUREMENT UNIT	13
12.5	COMPRESSORS REGULATION	13
12.6	FANS REGULATION	13
12.7	ALARMS – COMPRESSOR SECTION	14
12.8	ALARMS – FANS SECTION	14
12.9	ANALOG OUTPUT (OPTIONAL ONLY FOR XC440D)	14
12.10	OTHER	15
13.	TYPE OF REGULATION	15
13.1	DEAD BAND – ONLY FOR COMPRESSORS	15
13.2	PROPORTIONAL BAND – FOR COMPRESSORS OR FANS	16
14.	MOUNTING & INSTALLATION	17
15.	ELECTRICAL CONNECTIONS	18
15.1	PROBES CONNECTION	18
16.	RS485 SERIAL LINK	18
17.	ALARM LIST	18
17.1	TYPES OF ALARMS AND SIGNALLING MANAGED	19
17.2	ALARM MUTING	20
17.3	ALARM CONDITIONS – SUMMARY TABLE	20
18.	TECHNICAL FEATURES	21
19.	WIRING CONNECTIONS	22
20.	DEFAULT VALUE XR440C	22
21.	DEFAULT VALUE XR440D	24

1. General warning

1.1 Please read before using this manual

- This manual is part of the product and should be kept near the instrument for easy and quick reference.
- The instrument shall not be used for purposes different from those described hereunder. It cannot be used as a safety device.
- Check the application limits before proceeding.

1.2 Safety Precautions

- Check the supply voltage is correct before connecting the instrument.
- Do not expose to water or moisture: use the controller only within the operating limits avoiding sudden temperature changes with high atmospheric humidity to prevent formation of condensation
- Warning: disconnect all electrical connections before any kind of maintenance.
- The instrument must not be opened.
- In case of failure or faulty operation send the instrument back to the distributor or to "DIXELL S.p.A." (see address) with a detailed description of the fault.
- Consider the maximum current which can be applied to each relay (see Technical Data).
- Ensure that the wires for probes, loads and the power supply are separated and far enough from each other, without crossing or intertwining.
- Fit the probe where it is not accessible by the end user.
- In case of applications in industrial environments, the use of mains filters (our mod. FT1) in parallel with inductive loads could be useful.

2. General description

The **XC440C - XC440D** are designed to manage compressors or fans in a condensing systems such as a pack.

The compressors can be simple, multistage or with different capacities.

Control is by means of a neutral zone or proportional band and is based on the pressure or temperature sensed in the LP suction (compressors) or HP (condenser) circuits. A special algorithm balances the run hours of the compressors to distribute the work load uniformly. The controllers can convert pressure and display it as temperature.

The front panel offers complete information on the systems status by displaying the suction and condenser pressure (temperatures), the status of the loads, possible alarms or maintenance conditions.

Each load has its own alarm input that is able to stop it when activated.

By means of the HOT KEY the controller can be easy programmed at power on. The controller can be connected to the **dixell** controlling and monitoring system, thanks to the serial TTL output, using the standard ModBus RTU protocol.

3. First installation

At first installation, it's necessary the following:

1. **Select the kind of gas.**
2. **Set the range of the pressure probes.**

In the following paragraph a short cut for the above operations.

Chapters **6 Parameters programming** and **12 List of parameters** will explain in detail these operations.

3.1 How to set the kind of gas

The controller has memorised the relation between temperature and pressure for some gases.

The pre-set gases is: r404.

If another gas is used, act as in the following:

1. Enter the Programming mode by pressing the **Set** and **DOWN** key for 3s.
2. Select the "**Pr2**" parameter. Then enter the password 3 -2 1.
3. Select the **FtyP, kind of gas**, parameter.
4. Press the "**SET**" key: the value of the parameter will start blinking.
5. Use "**UP**" or "**DOWN**" to change the gas amount the following: . Select the gas among the following: **r22=R22; r404=R404A; 507=R507; 134=134; r717= ammonia.**
6. Press "**SET**" to store the new value and move to the following parameter.

To exit: Press **SET + UP** or wait 30s without pressing a key.

NOTE: the set value is stored even when the procedure is exited by waiting the time-out to expire.

3.2 How to set the range of the pressure probes

According to the part number a controller is pre-set to work with the following pressure probes: **XC440C - XC440D - xxxxA**, or **XC440C - XC440D - xxxxE**: PP11: -0.5÷11 bar (-7÷160 PSI) - relative pressure; **XC440C - XC440D - xxxxB**: PP30: 0÷30 bar (0÷435PSI) - relative pressure

If the probes you're using have a different range act as in the following:

To set the pressure range of the **Probe** use the parameters:

PA04: Adjustment of read out corresponding to 4mA
PA20: Adjustment of read out corresponding to 20mA

Practically these parameters has to be set with the start and end scale of the probe range.

WARNING: set a value correspondent to **absolute pressure**.

E.I. PP11 relative pressure transducer, range -0.5÷11.0 bar. PA04=0.50; PA20=12.00.

PP30 relative pressure transducer, range: 0÷30bar. PA04=1.00; PA20=31.00.

How to do:

1. Enter the Programming mode by pressing the **Set** and **DOWN** key for 3s.
 2. Select the "**Pr2**" parameter. Then enter the password 3 -2 1.
 3. Select the **PA04, adjustment of read out corresponding to 4mA**, parameter.
 4. Press the "**SET**" key: the value of the parameter will start blinking.
 5. Set the lower value of the probe range (lower value +1 if the probe detects relative pressure).
 6. Push the **SET** key to confirm the value. The **PA20: adjustment of read out corresponding to 20mA** parameter will be displayed.
 7. Set the higher value of the range (higher value +1 if the probe detects relative pressure).
 8. Push the **SET** key to confirm the value. Next parameter will be displayed.
- Do the same things for the Probe 2, **FA04, FA20** parameters.

3.3 How to set the kind of display: relative or absolute pressure

After setting the probe range by means of the PA04, PA20 parameters, it's possible to select if the absolute or relative pressure has to be displayed.

The controller is pre-set for **RELATIVE PRESSURE** displaying.

If the **absolute pressure** has to be displayed, act as in the following:

9. Enter the Programming mode by pressing the **Set** and **DOWN** key for 3s.
10. Select the "Pr2" parameter. Then enter the password 3 -2 - 1.
 1. Select by pushing the **UP** key the **rELP** parameter.
 2. Push the **SET** to modify the value.
 3. Set the **AbS** value and push the **SET** key to confirm it.

To exit: Press **SET + UP** or wait 30s without pressing a key.

4. User interface

XC440C

XC440D

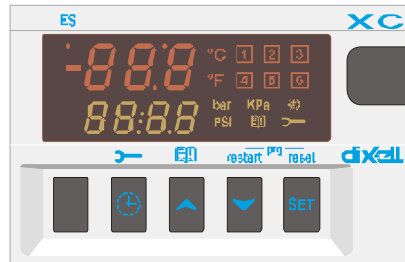

4.1 Displaying

UPPER DISPLAY	LOWER DISPLAY	ICONS
Temperature	Pressure	- Working loads - Measurement unit - Alarm or status Icons

4.2 Keyboard

SET To see or modify the set point. in programming mode it selects a parameter or confirm an operation.

Alarm menu: By holding it pressed for **3s**, the current alarm is erased.

▲ **(UP) To enter the Alarm menu.**

In programming mode: it browses the parameter codes or increases the displayed value.

With Hot key inserted: it starts the Hot key programming procedure.

▼ **(DOWN) In programming mode:** it browses the parameter codes or decreases the displayed value.















Manual restart of loads: By holding it pressed for **3s**, it switches on again loads previous locked by a safety digital input alarm.

-  **CLOCK** To display the loads running hours.
By holding it pressed for 3s the **Maintaining menu** is entered.

KEY COMBINATIONS

- ▲ + ▼** To lock and unlock the keyboard.
SET + ▼ To enter the programming mode.
SET + ▲ To exit the programming mode.

4.3 THE ICONS

LED	FUNCTION	MEANING
°C	ON	Celsius degrees
°F	ON	Fahrenheit degrees
bar	ON	bar displaying
PSI	ON	PSI displaying
	ON	Load 1 on
	Flashing	Load 1 is waiting to start (1Hz). or digital input alarm for Load 1 (2Hz). o Load 1 in maintenance status (2Hz).
	ON	Load 2 on
	Flashing	Load 2 is waiting to start (1Hz). or digital input alarm for Load 2 (2Hz). o Load 2 in maintenance status (2Hz).
	ON	Load 3 on
	Flashing	Load 3 is waiting to start (1Hz). or digital input alarm for Load 3 (2Hz). o Load 3 in maintenance status (2Hz).
	ON	Load 4 on
	Flashing	Load 4 is waiting to start (1Hz). or digital input alarm for Load 4 (2Hz). o Load 4 in maintenance status (2Hz).
	ON	Load 5 on
	Flashing	Load 5 is waiting to start (1Hz). or digital input alarm for Load 5 (2Hz). o Load 5 in maintenance status (2Hz).
	ON	The Maintenance menu has been entered
	Flashing	One or more loads have been placed in maintenance status
	ON	Alarm is happening
	ON	All the stored alarms have been seen
	Flashing	A new alarm has happened.

5. How to see and modify the set point

5.1 How to see the set point of compressors or fans

If the controller can manage compressors or fans, the set point are displayed in sequence, otherwise only the set point of the enabled section will be displayed.

 restart

 ▼

 prg

 SET

 reset



- 1) Push and release the **SET** key;
- 2) The Lower display will show the “**SEtC**” label for compressor/ “**SEtF**” label for fans, will the Upper display will show its value.

To exit: push the **SET** key or wait for 30 without pressing any keys.

5.2 How to modify the set point of compressors or fans

WARNING: before setting the target set points for the first time, check and, if necessary, modify the type of freon (par. FtyP) and the default unit of measurement (par. dEU) for compressors and fans

PROCEDURE

1. Set the kind of freon by means of the FtyP parameter (see 3.1 How to set the kind of gas)
2. Set the measurement unit (dEU par.).
3. Check and if necessary modify the set point limits (LSE and HSE par.).

 restart

 prg

 SET

 reset

1. Push the **SET** key for more than 2 seconds;
2. The Lower display will show the “SEtC” label for compressor/“SEtF” label for fans, will the Upper display will show its value flashing.
3. To change the Set value push the **▲** or **▼** within 30s.
4. To memorise the new value and pass to the normal display push the **SET** key.

To exit: push the **SET** key or wait for 30 without pressing any keys.

6. Parameters programming

6.1 How to enter the “Pr1” parameter list

 restart

 prg

 SET

 reset

To enter the “Pr1” parameter list, user accessible, operate as follows:

1. Hold pressed the **SET** and **DOWN** key for 3s.
2. The controller displays the name of the parameter in the Lower display, its value on the Upper display.
3. Press the “**SET**” key: the value of the parameter will start blinking.
4. Use “**UP**” or “**DOWN**” to change the value.
5. Press “**SET**” to store the new value and move to the following parameter.

To exit: Press **SET + UP** or wait 30s without pressing a key.

NOTE: the set value is stored even when the procedure is exited by waiting the time-out to expire.

6.2 How to enter in parameters list “Pr2”

The “Pr2” parameter list is protected by a security code (Password).

SECURITY CODE is 321

To access parameters in “Pr2”:

1. Enter the “Pr1” level.
2. Select “Pr2” parameter and press the “**SET**” key.
3. The flashing value “0 --” is displayed.
4. Use **▲** or **▼** to input the security code and confirm the figure by pressing “**SET**” key.
5. Repeat operations 2 and 3 for the other digits.

NOTE: each parameter in “Pr2” can be removed or put into “Pr1” (user level) by pressing “**SET**” + **▼**. When a parameter is present also in “Pr1” decimal point of the lower display is on.

6.3 How to change parameter values

1. Enter the Programming mode.
2. Select the required parameter with **▲** or **▼**.
3. Press the “**SET**” key the value start blinking.

4. Use ▲ or ▼ to change its value.
5. Press “**SET**” to store the new value and move to the following parameter.

To exit: Press **SET + UP** or wait 15s without pressing a key.

NOTE: the new programming is stored even when the procedure is exited by waiting the time-out.

7. How to disabled an output

To disabled an output during a maintenance session means to exclude the output from the regulation.

7.1 How to disabled an output during a maintenance session.



1. Push the **CLOCK** key for 3s.
2. The LED's of the first output is switched on, the Lower display shows the “**StA**” label, while the Upper display shows the “**On**” label

if the first output is enabled, or the “**oFF**” label if the output is disabled for a maintenance section.

With compressor with more steps all the LED's linked to the compressor and the valves are switched on..

3. Select the output by pressing the **UP** or **DOWN** key.
4. **To modify the status of the output:** push the **SET** key, the status of the output starts flashing, then push the UP or DOWN to pass from “**On**” to “**oFF**” and viceversa.
5. Push the **SET** key to confirm the status and pass to the next output..

To exit: push the **CLOCK** key or wait 30 sec

7.2 Output disabled signalling.

If an output is disabled its led blinks (2 Hz)

7.3 Regulation with some outputs disabled.

If some outputs are disabled they don't take part to the regulation, so the regulation goes on with the other outputs.

8. Running hours of loads

8.1 How to display the running hours of a load.

The controller memorises the running hours of each load.



To see how long a load has been working follow this procedure:

1. Press and release the “**CLOCK**” key.
2. The led of the first output is switched on, the Upper Display shows the “**HUR**” label, while the Lower Display shows the shows the running hours of the first output.
3. To see the running hours of the following load press the UP key .

To exit: push the **CLOCK** key or wait 30 sec

8.2 How to reset the running hours of a load.

1. Display the running hour according to the above procedure.
2. Select the load by pressing the UP key.
3. Push the **SET** key (immediately on the lower display the **rSt** label is displayed).
4. Hold pushed the key for some seconds till the “**rSt**” label starts flashing and the Lower display shows zero.

To exit: push the **CLOCK** key or wait 30 sec

NOTE: if the **SET** key is released within 2s, the controller reverts to display the running hours of the selected loads..

9. Alarm Menu

The controller memorises the last 20 alarms happened, together with their duration..

To see the alarm codes see par. **par. 17 Alarm list**

9.1 How to see the alarms



1. Push the **▲** key.
2. The last alarm happened is showed on the Upper display, while the lower display shows its number.
3. Push again the **▲** key and the other alarm are displayed starting from the most recent.

4. To see the alarm **duration** and push the **SET** key.
5. By pushing again the **▲** or **SET** key the next alarm is displayed.

Alarms erasing.

1. Enter the Alarm Menu.
2. To erase the displayed alarm push the **"SET"** key till the **"rSt"** label will be displayed in the Lower Display,
NOTE the running alarms cannot be erased..
3. To erase the whole Alarm Menu, hold pressed the **"SET"** key for 10s.

10. Use of the programming "HOT KEY "

10.1 How to program a hot key from the instrument (UPLOAD)

1. Program one controller with the front keypad.
2. When the controller is **ON**, insert the **"Hot key"** and push **▲** key; the **"uPL"** message appears followed a by flashing **"End"**
3. Push **"SET"** key and the **End** will stop flashing.
4. **Turn OFF** the instrument remove the **"Hot Key"**, then turn it **ON** again.

NOTE: the **"Err"** message is displayed for failed programming. In this case push again **▲** key if you want to restart the upload again or remove the **"Hot key"** to abort the operation.

10.2 How to program an instrument using a hot key (DOWNLOAD)

1. Turn OFF the instrument.
2. Insert a **programmed "Hot Key"** into the **5 PIN receptacle** and then turn the Controller **ON**.
3. Automatically the parameter list of the **"Hot Key"** is downloaded into the Controller memory, the **"doL"** message is blinking followed a by flashing **"End"**.
4. After 10 seconds the instrument will restart working with the new parameters.
5. Remove the **"Hot Key"**..

NOTE the message **"Err"** is displayed for failed programming. In this case turn the unit off and then on if you want to restart the download again or remove the **"Hot key"** to abort the operation.

The unit can **UPLOAD** or **DOWNLOAD** the parameter list from its own **E2** internal memory to the **"Hot Key"** and vice-versa.

11. Keyboard locking

11.1 How to lock the keyboard

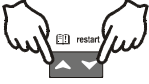

1. Keep the \blacktriangle and \blacktriangledown keys pressed together for more than 3 s the \blacktriangle and \blacktriangledown keys.
2. The "POF" message will be displayed and the keyboard is locked. At this point it is only possible to view the set point or enter the HACCP menu.

11.2 To unlock the keyboard

Keep the \blacktriangle and \blacktriangledown keys pressed together for more than 3s till the "PON" flashing message appears.

12. List of parameters

12.1 Plant dimensioning and type of regulation.

oA1, oA2, oA3, oA4 oA5 only for XC440D Outputs 1- 4(5) configuration: by means of these parameters the plant can be dimensioned according to the number and type of compressors or fans and the number of steps for each one.

Each relay according to the configuration of the oA(i) parameter can work as:

- **Compressor:** oAi = cPr,
- **Step:** oAi = StP
- **Fan:** oAi = FAn
- **Alarm:** oAi = ALr
- **Not used:** oAi = nu

NOTE: also the "Lin" value is present. This value **must not** be used..

According to the oA1÷oA5 configuration, 2 kinds of plant can be defined:

- ❖ **Rack with compressors only:** all the oAi different from FAn
- ❖ **Rack with fans only:** all the oAi different from CPr of StP

WARNING: It's not allowed to configure a plant with both compressors and fans.

COMPRESSORS CONFIGURATION

With **step compressors** the output of compressor has to be set before the output of the step.

ES. Compressor with 3 steps: **oA1 = cPr, oA2= StP, oA2 = StP, (oA5 = nu).**

If an oAi set as step without any previous oAi set as cPr the configuration alarm "CSStP" will be activated.

If compressor with different capacities are used (**CtyP=dPo**), all the oAi must to be configured as **cPr** (compressor) otherwise the **configuration alarm "CSStP" will be activated.**

RACK WITH FANS ONLY

If the controller is used for fans, all the oAi must be set as FAn or "nu" not used

CtyP: Compressor type: it selects if the compressors have the same power (homogeneous) or not.

dPo = compressor with different capacities: in this case the regulation is neutral zone.

StP = homogeneous: the regulation can be neutral zone or proportional band.

Scr = don't set it

StP valve outputs polarity: polarity of the outputs for capacity valves. It determines the state of the relays associated with the capacity valves (only for homogeneous and stepped-capacity compressors): **oP**=valve enabled with open contact; **cL**= valve enabled with closed contact.

PC1 ..PC4, PC5 only for XC440D Power of compressor 1...5: for setting the power of single compressors. Available only if CtyP=dPo. The power is identified by a value (range 1÷255) proportional to the capacity of single compressor.

E.I. 3 compressors with following capacity: 10, 20, 40 HP. The parameters have to be set in these way: PC1=10, PC2=20, PC3=40.

FtyP Freon Type: set the kind of freon used in the plant: **r22** = R22; **r404**= R404A ; **507**= R507; **134**=134; **r717**=r717 (ammonia),

rtv: Type of regulation (see par. 13 Type of regulation)

db = neutral zone, **Pb** = proportional band.

CH Type of action: CL = cooling (direct action); **Ht** = heating (inverse action).

with dead band regulation:

- if pressure/temperature is lower than regulation band, resources are activated.
- if pressure/temperature is bigger than regulation band, resources are deactivated.

with proportional band regulation:

- if pressure/temperature decreases crossing various bands, the resources are activated
- if pressure/temperature increases crossing various bands, the resources are deactivated

Sty Compressor rotation: YES = rotation: this algorithm distributes the working time between the various loads to ensure even run times. **no** = fixed sequence: the compressors are enabled and disabled in fixed sequence: first, second etc.

rot Fans rotation: YES = rotation: this algorithm distributes the working time between the various loads to ensure even run times. **no** = fixed sequence: the compressors are enabled and disabled in fixed sequence: first, second etc.

12.2 Probes configuration

12.2.1 Probe configuration

Pbc Probe 1 setting. Cur = 4 ÷ 20 mA probe; **ntc** = NTC probe, **Ptc** = NTC probe.

PA04 Adjustment of read out for the Probe 1 (used only if Pbc=Cur). corresponding to **4mA** input signal, given by the suction probe (0 ÷31 bar or 0÷450 PSI or 0÷3100KPA)

Warning: set a value correspondent to absolute pressure. If the transducer measures relative pressure increase the range of 1 bar.

See also par. 3.2 How to set the range of the pressure probes

E.I. **PP11** relative pressure transducer, range -0.5÷12.0 bar. PA04=0.5 (-0.5+1); PA20=12.0 (11+1).

PP30 relative pressure transducer, range: 0÷30bar. PA04=1; PA20=31.

PA20 Adjustment of read out for the Probe 1 corresponding to **20mA** input signal, given by the suction probe (0 ÷ 31.0 bar or 0÷450 PSI or 0÷3100KPA) **SEE THE WARNING FOR PA04.**

CAL Probe 1 calibration (-12.0÷12.0 bar; -12.0÷12.0 °C or -20÷20 PSI/°F)

12.3 Others inputs configuration

i1c Configurable digital input polarity (terminals 10-11 for XC440C and terminals 1-2 for XC440D): **oP**: the digital input is activated by opening the contact; **CL**: the digital input is activated by closing the contact.

i1F Configurable digital input polarity functions (terminals 10-11 for XC440C and terminals 1-2 for XC440D): **ES** = Energy saving; **oFF** = instrument shut down; **LLi** = liquid level alarm

did Configurable digital input delay: (enabled only if i1F=LL) 0÷255min

ALIP Alarm input for compressors and fans polarity: **oP**: the digital input is activated by opening the contact; **CL**: the digital input is activated by closing the contact.

ALMr Manual reset of alarms for compressors and fans.

no= automatic recover of alarm: regulation restart when the correspondent digital input is disabled; **yES** = manual recover for the alarms of compressors and fans

See also par. 17.1.2 EA1÷EA5: Compressors or fans safeties alarm.

12.4 Display and Measurement unit

dEU: Default measurement unit for displaying (bar=bar; °C=°C, PSI=PSI; °F=°F)

NOTE1: The **dEU** parameter sets the measurement unit also for the **set point** and the following parameters: **CAL, FCAL, Pbd, ESC, LSE, HSE, Pb, ESF, LSF, HSF, LAL, HA, LAF, HAF..**

NOTE2: The controller automatically converts values of set point and following parameters **CAL, FCAL, Pbd, ESC, LSE, HSE, Pb, ESF, LSF, HSF, LAL, HA, LAF, HAF** in the measurement unit set in **dEU** parameter. In any case after modifying this parameter it's better check and modify if necessary the set point and the above parameters.

rES Resolution for °C and bar (in = integer; dE = decimal point)

dSP2 Default visualisation of lower display: nu= not used; P1= probe one; P2= probe two; SET1; SET2

dEU2 Lower display probe format: PrS= Pressure; tPr= temperature

rELP Pressure displaying: AbS = absolute pressure; rEL = relative pressure.

NOTE: In this case the pressure displayed, the set point and the following parameters **LSE, HSE, LSF** and **HSF** are automatically decreased by 1.0 bar or 14 PSI

12.5 Compressors regulation

Pdb: Proportional band or neutral zone width (0.10÷5.00bar/0.5÷30°C or 1÷80PSI/1÷50°F)

The band (or zone) is symmetrical compared to the target set point, with extremes: set+Pdb/2 ... set-Pdb/2. The measurement unit depends on the **dEU** par.

ESC Energy saving value for compressors: (-20÷20bar; -50÷50°C) this value is add to the compressor set point.

Onon Minimum time between 2 following switching ON of the same compressor (0÷255 min).

oFon Minimum time between the switching off of a compressor and the following switching on. (0÷255min). *Note: usually onon is greater than oFon.*

Don Time delay between the insertion of two different compressors (0÷99.5min; res. 10s).

doF Time delay between switching off of two different compressors (0÷99.5 min; res. 10s)

donF Minimum time a stage stays switched ON (0÷99.5 min; res. 10s)

Maon Maximum time for compressor ON

FdLy "don" delay enabled also for the first call. If enabled, the triggering of the step is delayed for a "don" value, respect to the call. (no = "don" not enabled; yES="don" enabled)

FdLF "doF" delay enabled also for the first switching off. It enables the "doF" delay between the request of a release and the actual switching off. (no = "doF" not enabled; yES="doF" enabled)

Odo Regulation delay on start-up: (0÷255s) on switching ON the instrument starts working after the time delay imposed in this parameter.

LSE Minimum set point: The measurement unit depends on **dEU** parameter. It sets the minimum value that can be used for the set point, to prevent the end user from setting incorrect values.

HSE Maximum set point: The measurement unit depends on **dEU** parameter. It sets the maximum acceptable value for set point.

12.6 Fans regulation

Pb Proportional band zone width (0.10÷5.00bar/0.5÷30°C or 1÷80PSI/1÷50°F). **Set the dEU par. and the target set point for fans before setting this parameter.** The band is symmetrical compared to the target set point, with extremes: set+Pb/2 ... set-Pb/2. The measurement unit depends on the **dEU** par.

- ESF Energy saving value for fans:** (-20÷20bar; -50÷50°C) this value is add to the fans set point.
- Fon Time delay between the insertion of two different fans** (0÷255sec).
- FoF Time delay between switching off of two different compressors** (0÷255 sec)
- LSF Minimum set point for fans:** The measurement unit depends on dEU parameter. It sets the minimum value that can be used for the set point, to prevent the end user from setting incorrect values.
- HSF Maximum set point for fans:** The measurement unit depends on dEU parameter. It sets the maximum acceptable value for set point.

12.7 Alarms – compressor section

- PAo Alarm probe exclusion at power on.** it is the period starting from instrument switch on, before an alarm probe is signalled. (0÷255 min). During this time if the pressure is out of range all the compressor are switched on.
- LAL Low pressure (temperature) alarm – compressor section:** The measurement unit depends on dEU parameter. It's always subtracted to the set point. When the value **SET-LAL** is reached the A03C alarm is enabled, (possibly after the **tAo** delay time).
- HAL High pressure (temperature) alarm– compressor section:** The measurement unit depends on dEU parameter. It's always added to the set point. When the value **SET+HAL** is reached the A04C alarm is enabled, (possibly after the **tAo** delay time).
- tAo Low and High pressure (temperature) alarms delay– compressor section:** (0÷255 min) time interval between the detection of a pressure (temperature) alarm condition and alarm signalling.
- Ser Service request:** (1÷9990 hours, res. 10h) number of running hours after that the "A14" maintenance call is generated.
- SPr number of steps engaged with faulty probe.** (0÷#compr).
- PoPr capacity engaged with faulty probe** (0÷100%) It's used only if $CtyP=dPo$.

12.8 Alarms – fans section

- LAF Low pressure alarm – fans section:** The measurement unit depends on the dEU parameter. It's always referred to fan set point When the value **SETF-LAF** is reached the LA2 alarm is enabled, (possibly after the **AFd** delay time).
- HAF High pressure alarm – fans section:** The measurement unit depends on the dEU parameter. It's always referred to the set point. When the value **SETF+HAF** is reached the HA2 alarm is enabled, (possibly after the **AFd** delay time).
- AFd Low and High pressure alarms delay – fans section:** (0÷255 min) time interval between the detection of a pressure alarm condition in the fans section and alarm signalling.
- FPr Number of fans engaged with faulty probe.** (0÷#fans).

12.9 Analog output (optional only for XC440D)

- LAO Start of scale for analog output:** it's temperature (pressure) detected by the probe which is associated the 4mA value: (0.0÷51.0bar; -50.0÷150.0°C)
- UAO End of scale for analog output:** it's temperature (pressure) detected by the probe which is associated the 20mA value: (0.0÷51.0bar; -50.0÷150.0°C)
- AOM Minimum value for analog output** (4 ÷ 20mA)
- SAO Percentage of analog output in case of probe failure:** (0 ÷ 100%)

12.10 Other

- tbA Alarm relay silencing:** by pushing one of the keypad buttons. **no**= alarm relay stays on; **yES**= alarm relay is switched off by pushing any keys.
- OAP Alarm relay output polarity:** **cL**=closed when activated; **oP**= opened when activated
- oFF Switching ON/OFF enabling from keyboard:** (**no** = disabled; **yES** = enabled) It permits the switching ON/OFF of the instrument by pressing the SET key for more than 4s.
- Ad1 Compressors address** (1 –247) It is used in monitoring system.
- Ad2 Fans address** (1 –247) It is used in monitoring system.
- rEL Software release** for internal use.
- Ptb Parameter table code:** readable only.
- Pr2 Access to security code protected menu**

13. Type of regulation

13.1 Dead band – Only for compressors

This kind of regulation is available only for compressors. The neutral zone (Pbd) is symmetrical compared to the target set point, with extremes: $set + Pbd/2$... $set - Pbd/2$. If the pressure (temperature) is inside this zone the controller maintains the same number of loads switched on and off, without changing anything.

When the pressure (temperature) go out from the zone, regulation starts. If the pressure is greater than $SET + Pbd/2$, the loads are switching on with timing given by parameters: **don** and **doF**.

A load is turned on only if the his safety times **onon**, **oFon**, **donF** are over.

Regulation stops when the pressure (temperature) come back into the neutral zone.

In the following a simplify exemplum that explains the regulation in neutral zone for compressor homogeneous with 1 step for each compressors. The safety times **onon**, **oFon** and **donF** are not considered. In the real regulation the a load is entered or turned off only if these times are over.

Ex. Dead band control, compressors with same capacities, 1 step for each compressor.

In this example:

oA1 = cPr; oA2 = cPr; oA3 = cPr; oA4 = nu; number of compressors

CtyP = SPo homogeneous compressors;

rty = db dead band regulation

Sty = yES rotation

FdLy = no "don" delay not enabled at first calling after an equilibrium condition.

dLF = no "doF" delay not enabled at first calling after an equilibrium condition.

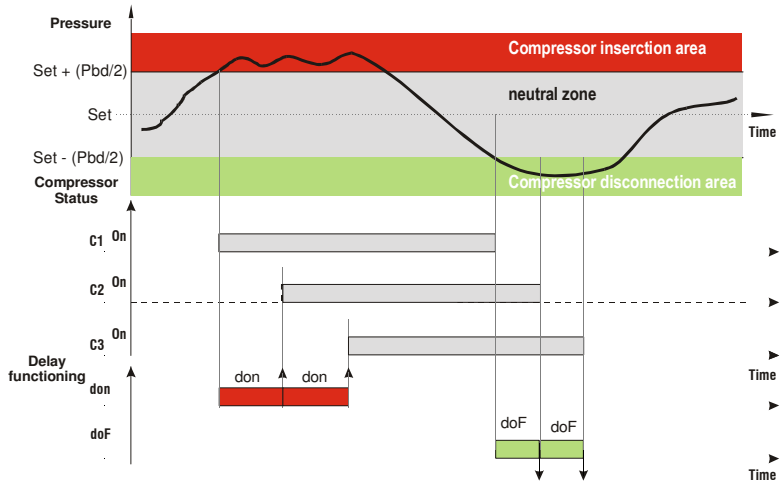

13.2 Proportional Band – for compressors or fans

The regulation band (Pbd) is divided into as many parts as there are stages according to the following formula:

step = oAi = CPr or StP (number of compressors or steps).

The numbers of stages switched ON is proportional to the value of the input signal: when this distances itself from the target set point and enters the various bands, the compressors are switched ON, to be then turned OFF when the signal brings near the set point.

In this way if the pressure is greater than regulation band, all the compressors are on, if the pressure (temperature) is lower than the regulation band all the compressors are off. Naturally also for this regulations all the delays (don and doF) safety times (onon, oFon and donF) are valid.

Regulation according to the running hours

The algorithm switch on and off the loads according to the running hours of each load. In this way the running hours are balanced.

Example

oA1 = cPr; oA2 = cPr; oA3 = cPr; oA4 = cPr: 4 compressors
 CtyP = SPo homogeneous compressors.
 rty = Pb proportional band regulation
 Sty = yESrotation
 FdLy = no "don" delay at first call not enabled.
 dLF= no "doF" delay at first call not enabled.

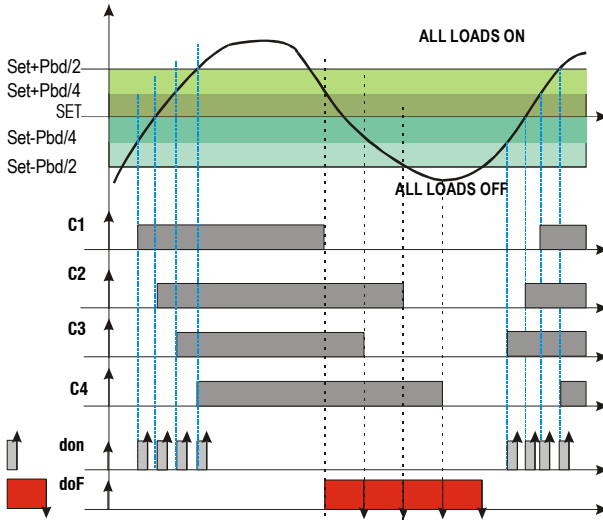

This draw highlights the doF time: the loads are in fact turned off only when the doF time is over.

14. Mounting & installation

The instruments are suitable only for internal use. Instruments shall be mounted on panel, in a 29x71 mm hole, and fixed using the special brackets supplied.

To obtain an IP65 protection grade use the front panel rubber gasket (mod. RG-C) as shown in figure. The ambient operating temperature range is between 0÷60 °C.

Avoid locations subject to heavy vibration, corrosive gases or excessive dirt. The same applies to the probes. Ensure ventilation around the instrument.

The **XC440D** shall be mounted on an omega DIN rail. The temperature range allowed for correct operation is 0÷60 °C. Avoid places subject to strong vibrations, corrosive gases, excessive dirt or humidity. The same recommendations apply to probes. Let air circulate by the cooling holes.

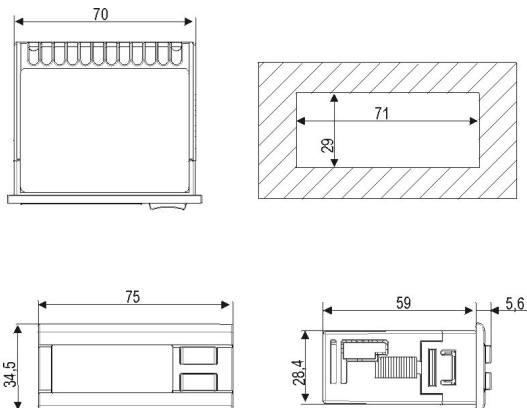

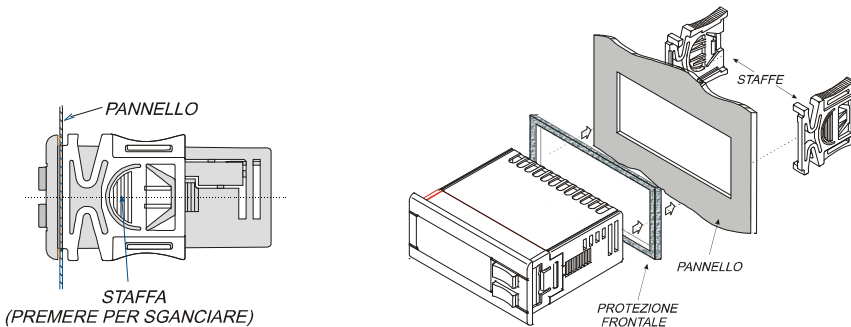

Figure 1

15. Electrical connections

The controller is provided with screw terminal blocks for wires having section not bigger than 2.5 mm²:

Check power supply data before connection wires.

Keep the probe and the digital input wires separate from the power cable.

Do not exceed the maximum rating current for each relay, check technical data and if the load is bigger, use filtered contactors.

Before connecting cables make sure the power supply complies with the instrument's requirements. Separate the input connection cables from the power supply cables, from the outputs and the power connections. **Do not exceed the maximum current allowed on each relay**, in case of heavier loads use a suitable external relay.

15.1 Probes connection

Pressure probe (4 - 20 mA): respect the polarity. If using terminal ends be sure there are no bare parts which could cause short circuiting or introduce noise disturbance at high frequencies. To minimise the induced disturbances use shielded cables with the shield connected to earth.

Temperature probe: it is recommended to place the temperature probe away from direct air streams to correctly measure the temperature.

16. RS485 serial link

All models can be integrated into the monitoring and alarm system XJ500 using the TTL serial port. They use the standard ModBus RTU protocol, so they can be fitted in a system integrator using this protocol.

The controller has 2 serial addresses first one Ad1 for compressor section, second one Ad2 for fan section.

XJ500: Use Ad1 parameter for Compressor, and Ad2 for fans.

If the Ad2 parameters have the same value of Ad1, the status of the fans is not monitored.

X-WEB300/3000: the values of the 2 addresses Ad1 and Ad2 can be the same.

17. Alarm list

Usually alarm conditions are signalled by means of:

1. Activation of alarm output relay
2. Buzzer activation

3. Message on proper display
4. Log of alarm: code and duration.

The table at paragraph 17.3

17.1 Types of alarms and signalling managed

17.1.1 A12: Configuration alarm

The following configuration parameters are checked after each modification.:

- OA1 ÷ OA5** Outputs 1- 5 configuration
CtyP Compressor type

When these parameters are set in wrong way an alarm message is generated: the label A12 is shown on the upper display, while the lower display signals what wrong setting has created the error:

The following table contains the displayed messages:

Mess.	Errata	Corrige
nLod	Number of loads higher than loads available in the controller	<ul style="list-style-type: none"> • Check number of oAi set as load, this number has to be lower of equal to the number of relay of the controller.
cStP	Load (step) configuration error	<ul style="list-style-type: none"> • A relay oA(i) has been set as compressor without a previous relay oA(i-1) has been set as compressor. EI oA1 = StP
FAP2	P2 probe not available for fan regulation	<ul style="list-style-type: none"> • Some relays have been set as compressors (oAi = CPr) some others have been set as fans (oAi = FAn). Set all the oAi as compressors or fans.
CSP2	P2 probe not available for screw compressor	<ul style="list-style-type: none"> • Check CtyP and set it different from Scr.

17.1.2 EA1÷EA5: Compressors or fans safeties alarm.

Terminals

WARNING: THESE TERMINALS REQUIRE A FREE OF VOLTAGE CONNECTION.

The terminals really used depends on the number of loads. The protections regarding the compressors and fans are connected to these inputs. If one of these protections is enabling (E.I. for lack of oil or overheating, etc,) the corresponding load is turn off.

Parameters

ALIP: It establishes if the input is activated by closing (ALIP = cL) or by opening (ALIP = oP) the terminals.

Actions

Every time one input is activated the corresponding output is turned off.

Recovery

Recovery depends on **ALMr** parameter:

With **ALMr = no** The instrument restart the standard operating mode when the input is disabled.

With **ALMr = yES** manual recover for the alarms of compressors and fans. Push the **DOWN** key for 3s.

17.1.3 P1: probe failure alarm

It is generated by failure in the probe P1.

Parameters

According to the configuration of the controller one of the following parameters is used:

SPr: number of steps engaged with faulty probe. (0÷# oAi = cPr or StP).

PoPr: capacity engaged with faulty probe (0÷255) It's used only if CtyP=dPo.

FPr: Number of fans engaged with faulty probe. (0÷# oAi = FAn)

Recovery

Automatic as soon as probe restarts working.

17.1.4 HA, LA, HA2, LA2 High and low pressure (temperature) alarms

This alarm signals that the pressure (temperature) is out of limits established by parameters LAL and HAL for compressors and LAF –HAF for fans.

The **tAo** and **AFd** parameters set the delay between alarm condition and alarm signalling.

Action

The alarm is signalled with standard action. The outputs are unchanged.

17.2 Alarm muting

Press any buttons to silence the buzzer during an alarm condition.

Hold pressed for more than 3 seconds switch off the alarm relay during an alarm condition

17.3 Alarm conditions – summary table

Code	Description	Cause	Action	Reset
P1	P1 probe failure alarm	Probe failure or out of range	The compressors are activated according to the SPr or PoPr parameters.	Automatically as soon as the probe restarts working.
EA1 EA2 EA3 EA4 EA5	Load safeties alarm	Safeties compressor/fan input activation. NOTE: with step compressors 1 input for each compressor has to be used.	the corresponding load is turned off. (with step compressors all relays referred to the input are disabled).	Recovery depends on ALMr parameter: With ALMr = no The instrument restart the standard operating mode when the input is disabled. With ALMr = yES manual recover for the alarms of compressors and fans. Push the DOWN key for 3s.
LA	Minimum pressure (temperature) alarm for compressors	Suction pressure or temperature lower than SET_C-LAL value	signalling only	Automatically : as soon as the pressure or temperature reaches the (Set_C-LAL+ differential) value. (differential = 0.3bar or 1°C)
LA2	Minimum pressure (temperature) alarm for fans	Condensing pressure or temperature lower than SET_F-LAL value	signalling only	Automatically : as soon as the pressure or temperature reaches the (Set_F-LAL+ differential) value. (differential = 0.3bar or 1°C)
HA	Maximum pressure (temperature) alarm for compressors	Suction pressure or temperature higher than SET_C+HAL value	signalling only	Automatically : as soon as the pressure or temperature reaches the (Set_C + HAL - differential) value. (differential = 0.3bar or 1°C)
HA2	Maximum pressure (temperature) alarm for fans	Condensing pressure or temperature higher than SET_F+HAL value	signalling only	Automatically : as soon as the pressure or temperature reaches the (Set_F + HAL - differential) value. (differential = 0.3bar or 1°C)
A5	Liquid level alarm	Input enabled	signalling only	Automatically as soon as the input is disabled

Code	Description	Cause	Action	Reset
A14	Load maintenance alarm	A load has worked for the hour set in the SER parameter	signalling only	Manually: reset the running hour of the compressor (see par. 8 Running hours of loads)

18. Technical features

Housing: Self extinguishing ABS.

Case: **XC440C** Front panel 32x74 mm, depth 60mm;
XC440D DIN modules 70x85 mm; depth 61mm

Mounting : **XC440C** panel mounting in a 29x71 mm panel cut-out
XC440D DIN RAIL mounted in a omega (3) din rail

Frontal protection: IP65 with frontal gasket mod RG-C model.

Connections: screw terminal block,

Power supply: **XC440C** 12Vac/dc $\pm 10\%$, 24Vac/dc $\pm 10\%$, 50-60Hz.
XC440D 110Vac $\pm 10\%$, 230Vac $\pm 10\%$, 50-60Hz

Power absorption: 5VA max.

Display: 3 digits red led and 4 digit orange led.

Inputs: 1 NTC probe, or 1 PTC probe or 1 4÷20mA transducer.

Digital inputs: **XC440C** 5 free voltage;
XC440D 6 free voltage;

Relay outputs: 5 relay SPST 8(3)A, 250Vac

Serial output : TTL standard

Communication protocol: ModBus – RTU

Data storing: on the non-volatile memory (EEPROM).

Kind of action: 1B; **Pollution grade:** normal; **Software class:** A.

Operating temperature: 0÷60 °C.; **Storage temperature:** -25÷60 °C.

Relative humidity: 20÷85% (no condensing)

Measuring range: NTC probe: -40÷110 °C.

Resolution: 0,1 °C or 1 °C; **Accuracy (ambient temp. 25 °C):** $\pm 0,7$ °C ± 1 digit

19. Wiring connections

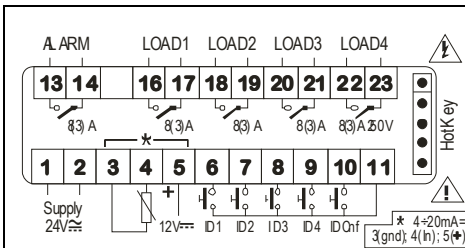

Probe:

PP11 / PP30: Brown (5), White (4)
PTC/NTC: 3-4

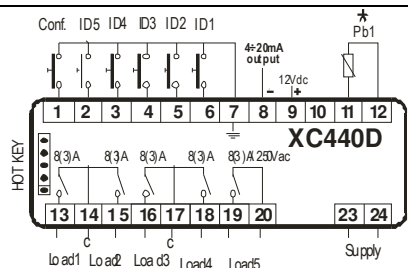

Probe:

PP11 / PP30: Brown (9), White (11)
PTC/NTC: 11-12

20. Default value XR440C

Fans parameters

Compressor parameters

Commons parameters

Name	°C	°F	bar	PSI	Level	Description	Range
SEtC	-18,0	0	2,3	33	--	Set point for compressors	LSE+HSE
SEtF	35,0	95	15,1	220	--	Set point for fans	LSF+HSF
OA1	CPr	CPr	CPr	CPr	Pr2	Outputs 1 configuration	CP(0) - FAn(1) - StP(2) - ALr(3) - Lln(4) - nu(5)
OA2	CPr	CPr	CPr	CPr	Pr2	Outputs 2 configuration	CP(0) - FAn(1) - StP(2) - ALr(3) - Lln(4) - nu(5)
OA3	CPr	CPr	CPr	CPr	Pr2	Outputs 3 configuration	CP(0) - FAn(1) - StP(2) - ALr(3) - Lln(4) - nu(5)
OA4	CPr	CPr	CPr	CPr	Pr2	Outputs 4 configuration	CP(0) - FAn(1) - StP(2) - ALr(3) - Lln(4) - nu(5)
CtyP	SPo	SPo	SPo	SPo	Pr2	Compressor type	SPo(0) - dPo(1) - Scr(2)
StP	CL	CL	CL	CL	Pr2	Valve outputs polarity	OP(0) - CL(1)
PC1	25	25	25	25	Pr2	Power of compressor 1	0 ÷ 255
PC2	25	25	25	25	Pr2	Power of compressor 2	0 ÷ 255
PC3	25	25	25	25	Pr2	Power of compressor 3	0 ÷ 255
PC4	25	25	25	25	Pr2	Power of compressor 4	0 ÷ 255
FtyP	404	404	404	404	Pr2	Freon Type	r22(0) - 404(1) - 507(2) - 134(3) - 717(4)
rty	db	db	db	db	Pr2	Type of regulation	db(0) - Pb(1)
CH	CL	CL	CL	CL	Pr2	Type of action	cl ÷ Ht
Sty	yES	yES	yES	yES	Pr2	Compressor rotation	no(0) - yES(1)
rot	yES	yES	yES	yES	Pr2	Fans rotation	no(0) - yES(1)
PbC	Cur	Cur	Cur	Cur	Pr2	Probe 1 setting	Cur(0) - Ptc(1) - ntc(2)
PA04	0,5	7	0,5	7	Pr2	Adjustment of read out for the Probe at 4mA	(0,0 ÷ PA20)BAR (0 ÷ PA20)PSI

Name	°C	°F	bar	PSI	Level	Description	Range
PA20	12,0	174	12,0	174	Pr2	Adjustment of read out for the Probe at 20mA	(PA04 ÷ 51.0)BAR (PA04 ÷ 750)PSI
CAL	0	0	0	0	Pr2	Probe calibration	(dEU=bar o °C) -12.0 ÷ 12.0 (dEU=PSI o °F) -20 ÷ 20
i1C	cL	cL	cL	cL	Pr2	Configurable digital input polarity	OP(0) - CL(1)
i1F	ES	ES	ES	ES	Pr2	Configurable digital input polarity functions	ES(0) - OFF(1) - LL(2)
did	0	0	0	0	Pr2	Configurable digital input delay	0 ÷ 255 (min.)
ALIP	CL	CL	CL	CL	Pr2	Alarm input for compressors and fans polarity	OP(0) - CL(1)
ALMr	no	no	no	no	Pr2	Manual reset of alarms for compressors and fans	no(0) - yES(1)
dEU	°C	°F	bar	PSI	Pr2	Default measurement unit for displaying	Bar(0) - °C(1) - PSI(2) - °F(3)
rES	dE	in	dE	in	Pr2	Resolution for °C and bar	in(0) - dE(1)
dSP2	P1	P1	P1	P1	Pr2	Default visualisation of lower display	nu - P1 - P2 - SE1 - SE2
dEU2	PrS	PrS	PrS	PrS	Pr2	Lower display probe format	PrS ÷ tPr
rELP	rEL	rEL	rEL	rEL	Pr2	Pressure displaying	rEL(0) - AbS(1)
Pdb	4	8	0.5	7	Pr2	Proportional band or neutral zone width	(BAR) 0.1÷10.0 (°C) 0.1÷30.0 (PSI) 1÷80 (°F) 1÷50
ESC	0	0	0	0	Pr2	Energy saving value for compressors	(BAR) -20.0÷20.0 (°C) -50.0÷50.0 (PSI) -300÷300 (°F) -90÷90
OnOn	5	5	5	5	Pr2	Minimum time between 2 following switching ON of the same compressor	0 ÷ 255 (min.)
OFOn	2	2	2	2	Pr2	Minimum time between the switching off of a compressor and the following switching on	0 ÷ 255 (min.)
don	0,3	0,3	0,3	0,3	Pr2	Time delay between the insertion of two different compressors	0 ÷ 99.5 (min.10sec)
doF	0,1	0,1	0,1	0,1	Pr2	Time delay between switching off of two different compressors	0 ÷ 99.5 (min.10sec)
donF	0,3	0,3	0,3	0,3	Pr2	Minimum time a stage stays switched ON	0 ÷ 99.5 (min.10sec)
MAon	0	0	0	0	Pr2	Maximum time for compressor ON	0 ÷ 24 h
FdLy	no	no	no	no	Pr2	"don" delay enabled also for the first call	no(0) - yES(1)
FdLF	no	no	no	no	Pr2	doF" delay enabled also for the first switching off	no(0) - yES(1)
odo	20	20	20	20	Pr2	Regulation delay on start-up	0 ÷ 255 (sec.)
LSE	-40	-40	0,3	5	Pr2	Minimum set point)	BAR: (PA04÷HSE)abs; ((PA04-1.013)÷HSE)rel; °C: -50.0÷HSE; PSI: (PA04÷HSE)abs o ((PA04-14)÷HSE)rel; °F: -58.0÷HSE
HSE	10	50	7,2	100	Pr2	Maximum set point	BAR :(LSE÷PA20)abs o (LSE÷(PA20-1.013))rel; °C:LSE ÷ 150.0; PSI:(LSE ÷ PA20)abs o (LSE÷(PA20-14))rel; °F: LSE ÷ 302
Pb	4	8	2.0	24	Pr2	Proportional band zone width	(BAR) 0.1÷10.0 (°C) 0.1÷30.0 (PSI) 1÷80 (°F) 1÷50.0
ESF	0	0	0	0	Pr2	Energy saving value for fans	(BAR) -20.0÷20.0 (°C) -50.0÷50.0 (PSI) -

Name	°C	°F	bar	PSI	Level	Description	Range
							300÷300 (°F) -90÷90
Fon	15	15	15	15	Pr2	Time delay between the insertion of two different fans	0 ÷ 255 (sec)
FoF	5	5	5	5	Pr2	Time delay between switching off of two different fans	0 ÷ 255 (sec)
LSF	10	50	7,2	100	Pr2	Lower set for fans	BAR:(FA04 ÷ HSF)abs, ((FA04 - 1.013) ÷ HSF)rel; °C:-50.0 ÷ HSF; PSI: (FA04 ÷ HSF)abs o ((FA04-14) ÷ HSF)rel; °F: -58.0 ÷ HSF
HSF	60	140	27,8	404	Pr2	Higher set for fans	BAR: (LSF ÷ F20); abs: (LSF ÷ (F20-1.0))rel; °C:LSF ÷ 150.0; PSI: (LSF ÷ FA20)abs o (LSF÷(FA20 - 14))rel; °F: LSF ÷ 302
PAO	30	30	30	30	Pr2	Alarm probe exclusion at power on	0 ÷ 255 (min.)
LAL	15,0	30	1,5	21	Pr1	Low pressure (temperature) alarm – compressor section	(0.1 ÷ 30.0)BAR (0.1 ÷ 100.0)°C (1 ÷ 430)PSI (1 ÷ 200.0)°F
HAL	20.0	40	2,5	46	Pr1	High pressure (temperature) alarm– compressor section	(0.1 ÷ 30.0)BAR (0.1 ÷ 100.0)°C (1 ÷ 430)PSI (1 ÷ 200.0)°F
tAo	15	15	15	15	Pr1	Low and High pressure (temperature) alarms delay– compressor section	0 ÷ 255 (min.)
SEr	999	999	999	999	Pr2	Service request	1 ÷ 999 (0= ESCLUSO) (10 ore)
SPr	2	2	2	2	Pr2	number of steps engaged with faulty probe	0 ÷ (nCPR)
PoPr	50	50	50	50	Pr2	capacity engaged with faulty probe	0 ÷ 100 (%)
LAF	20	40	6,7	96	Pr1	Low pressure alarm – fans section	(0.1 ÷ 30.0)BAR (0.1 ÷ 100.0)°C (1 ÷ 430)PSI (1 ÷ 200.0)°F
HAF	20	40	9,8	141	Pr1	High pressure alarm – fans section	(0.1 ÷ 30.0)BAR (0.1 ÷ 100.0)°C (1 ÷ 430)PSI (1 ÷ 200.0)°F
AFd	15	15	15	15	Pr2	Low and High pressure alarms delay – fans section	0 ÷ 255 (min)
FPr	2	2	2	2	Pr2	Number of fans engaged with faulty probe	0 ÷ (nFAN)
tbA	yES	yES	yES	yES	Pr2	Alarm relay silencing	no(0) - yES(1)
OAP	cL	cL	cL	cL	Pr2	Alarm relay output polarity	cL ÷ oP
oFF	no	no	no	no	Pr2	Switching ON/OFF enabling from keyboard	no(0) - yES(1)
Ad1	1	1	1	1	Pr2	Compressors address	1 ÷ 247
Ad2	1	1	1	1	Pr2	Fans address	1 ÷ 247
rEL					Pr1	Software release	read only
Ptb					Pr1	Parameter table code	read only
Pr2					Pr1	Protected parameter menu	read only

21. Default value XR440D

Fans parameters

Compressor parameters

Commons parameters

Name	°C	°F	bar	PSI	Level	Description	Range
SEtC	-18,0	0	2,3	33	--	Set point for compressors	LSE÷HSE

Name	°C	°F	bar	PSI	Level	Description	Range
SEtF	35,0	95	15,1	220	--	Set point for fans	LSF+HSF
OA1	CPr	CPr	CPr	CPr	Pr2	Outputs 1 configuration	CPr(0) - FAn(1) - StP(2) - ALr(3) - LIn(4) - nu(5)
OA2	CPr	CPr	CPr	CPr	Pr2	Outputs 2 configuration	CPr(0) - FAn(1) - StP(2) - ALr(3) - LIn(4) - nu(5)
OA3	CPr	CPr	CPr	CPr	Pr2	Outputs 3 configuration	CPr(0) - FAn(1) - StP(2) - ALr(3) - LIn(4) - nu(5)
OA4	CPr	CPr	CPr	CPr	Pr2	Outputs 4 configuration	CPr(0) - FAn(1) - StP(2) - ALr(3) - LIn(4) - nu(5)
OA5	ALr	ALr	ALr	ALr	Pr2	Outputs 5 configuration	CPr(0) - FAn(1) - StP(2) - ALr(3) - LIn(4) - nu(5)
CtyP	SPo	SPo	SPo	SPo	Pr2	Compressor type	SPo(0) - dPa(1) - Scr(2)
SP	CL	CL	CL	CL	Pr2	Valve outputs polarity	OP(0) - CL(1)
PC1	25	25	25	25	Pr2	Power of compressor 1	0 ÷ 255
PC2	25	25	25	25	Pr2	Power of compressor 2	0 ÷ 255
PC3	25	25	25	25	Pr2	Power of compressor 3	0 ÷ 255
PC4	25	25	25	25	Pr2	Power of compressor 4	0 ÷ 255
PC5	0	0	0	0	Pr2	Power of compressor 5	0 ÷ 255
FtyP	404	404	404	404	Pr2	Freon Type	r22(0) - 404(1) - 507(2) - 134(3) - 717(4)
rtY	db	db	db	db	Pr2	Type of regulation	db(0) - Pb(1)
CH	CL	CL	CL	CL	Pr2	Type of action	cl ÷ ht
Sty	yES	yES	yES	yES	Pr2	Compressor rotation	no(0) - yES(1)
rot	yES	yES	yES	yES	Pr2	Fans rotation	no(0) - yES(1)
PbC	Cur	Cur	Cur	Cur	Pr2	Probe 1 setting	Cur(0) - Ptc(1) - ntc(2)
PA04	0,5	7	0,5	7	Pr2	Adjustment of read out for the Probe at 4mA	(0.0 ÷ PA20)BAR (0 ÷ PA20)PSI
PA20	12,0	174	12,0	174	Pr2	Adjustment of read out for the Probe at 20mA	(PA04 ÷ 51.0)BAR (PA04 ÷ 750)PSI
CAL	0	0	0	0	Pr2	Probe calibration	(dEU=bar o °C) -12.0 ÷ 12.0 (dEU=PSI o °F) -20 ÷ 20
i1C	cL	cL	cL	cL	Pr2	Configurable digital input polarity	OP(0) - CL(1)
i1F	ES	ES	ES	ES	Pr2	Configurable digital input polarity functions	ES(0) - OFF(1) - LL(2)
did	0	0	0	0	Pr2	Configurable digital input delay	0 ÷ 255 (min.)
ALIP	CL	CL	CL	CL	Pr2	Alarm input for compressors and fans polarity	OP(0) - CL(1)
ALMr	no	no	no	no	Pr2	Manual reset of alarms for compressors and fans	no(0) - yES(1)
dEU	°C	°F	bar	PSI	Pr2	Default measurement unit for displaying	Bar(0) - °C(1) - PSI(2) - °F(3)
rES	dE	in	dE	in	Pr2	Resolution for °C and bar	in(0) - dE(1)
dSP2	P1	P1	P1	P1	Pr2	Default visualisation of lower display	nu - P1 - P2 - SEt1 - SEt2
dEU2	PrS	PrS	PrS	PrS	Pr2	Lower display probe format	PrS ÷ tPr
rELP	rEL	rEL	rEL	rEL	Pr2	Pressure displaying	rEL(0) - Abs(1)
Pbd	4	8	0.5	7	Pr2	Proportional band or neutral zone width	(BAR) 0.1÷10.0 (°C) 0.1÷30.0 (PSI) 1÷80 (°F) 1÷50
ESC	0	0	0	0	Pr2	Energy saving value for compressors	(BAR) -20.0÷20.0 (°C) -50.0÷50.0 (PSI) -300÷300 (°F) -90÷90
OnOn	5	5	5	5	Pr2	Minimum time between 2 following switching ON of the same compressor	0 ÷ 255 (min.)

Name	°C	°F	bar	PSI	Level	Description	Range
OFO _n	2	2	2	2	Pr2	Minimum time between the switching off of a compressor and the following switching on	0 ÷ 255 (min.)
don	0,3	0,3	0,3	0,3	Pr2	Time delay between the insertion of two different compressors	0 + 99.5 (min.10sec)
doF	0,1	0,1	0,1	0,1	Pr2	Time delay between switching off of two different compressors	0 + 99.5 (min.10sec)
donF	0,3	0,3	0,3	0,3	Pr2	Minimum time a stage stays switched ON	0 ÷ 99.5 (min.10sec)
MA _{on}	0	0	0	0	Pr2	Maximum time for compressor ON	0 ÷ 24 h
FdLy	no	no	no	no	Pr2	"don" delay enabled also for the first call	no(0) - yES(1)
FdLF	no	no	no	no	Pr2	doF" delay enabled also for the first switching off	no(0) - yES(1)
odo	20	20	20	20	Pr2	Regulation delay on start-up	0 ÷ 255 (sec.)
LSE	-40	-40	0,3	5	Pr2	Minimum set point)	BAR: (PA04+HSE)abs; ((PA04-1.013)+HSE)rel; °C: -50.0+HSE; PSI: (PA04+HSE)abs o ((PA04-14)+HSE)rel; °F: -58.0+HSE
HSE	10	50	7,2	100	Pr2	Maximum set point	BAR : (LSE+PA20)abs o (LSE+(PA20-1.013))rel; °C:LSE ÷ 150.0; PSI:(LSE ÷ PA20)abs o (LSE÷(PA20-14))rel; °F: LSE ÷ 302
Pb	4	8	2.0	24	Pr2	Proportional band zone width	(BAR) 0.1÷10.0 (°C) 0.1÷30.0 (PSI) 1÷80 (°F) 1÷50.0
ESF	0	0	0	0	Pr2	Energy saving value for fans	(BAR) -20.0÷20.0 (°C) -50.0÷50.0 (PSI) -300÷300 (°F) -90÷90
Fon	15	15	15	15	Pr2	Time delay between the insertion of two different fans	0 ÷ 255 (sec)
FoF	5	5	5	5	Pr2	Time delay between switching off of two different fans	0 ÷ 255 (sec)
LSF	10	50	7,2	100	Pr2	Lower set for fans	BAR:(FA04 ÷ HSF)abs ((FA04 - 1.013) ÷ HSF)rel; °C:-50.0 ÷ HSF; PSI: (FA04 ÷ HSF)abs o ((FA04-14) ÷ HSF)rel; °F: -58.0 ÷ HSF
HSF	60	140	27,8	404	Pr2	Higher set for fans	BAR : (LSF ÷ F20)abs (LSF ÷ (F20-1.013))rel; °C:LSF ÷ 150.0; PSI: (LSF ÷ FA20)abs o (LSF÷(FA20 - 14))rel; °F: LSF ÷ 302
PAO	30	30	30	30	Pr2	Alarm probe exclusion at power on	0 ÷ 255 (min.)
LAL	15,0	30	1,5	21	Pr1	Low pressure (temperature) alarm – compressor section	(0.1 ÷ 30.0)BAR (0.1 ÷ 100.0)°C (1 ÷ 430)PSI (1 ÷ 200.0)°F
HAL	20,0	40	2,5	46	Pr1	High pressure (temperature) alarm– compressor section	(0.1 ÷ 30.0)BAR (0.1 ÷ 100.0)°C (1 ÷ 430)PSI (1 ÷ 200.0)°F
tAo	15	15	15	15	Pr1	Low and High pressure (temperature) alarms delay– compressor section	0 ÷ 255 (min.)
SEr	999	999	999	999	Pr2	Service request	1 ÷ 999 (0= ESCLUSO) (10 ore)
SPr	2	2	2	2	Pr2	number of steps engaged with faulty probe	0 ÷ (nCPR)
PoPr	50	50	50	50	Pr2	capacity engaged with faulty probe	0 ÷ 100 (%)
LAF	20	40	6,7	96	Pr1	Low pressure alarm – fans section	(0.1 ÷ 30.0)BAR (0.1 ÷ 100.0)°C (1 ÷

Name	°C	°F	bar	PSI	Level	Description	Range
							430PSI (1 ÷ 200.0)°F
HAF	20	40	9,8	141	Pr1	High pressure alarm – fans section	(0.1 ÷ 30.0)BAR (0.1 ÷ 100.0)°C (1 ÷ 430)PSI (1 ÷ 200.0)°F
AFd	15	15	15	15	Pr2	Low and High pressure alarms delay – fans section	0 ÷ 255 (min)
FPr	2	2	2	2	Pr2	Number of fans engaged with faulty probe	0 ÷ (nFAN)
LAO	0	0	0	0	Pr2	Start of scale for analog output	AOC=Pb : 0.0÷51.0(BAR) - 50.0÷150.0(°C) 0÷750(Psi) - 58÷302(°F);
UAO	1	1	1	1	Pr2	End of scale for analog output	AOC=Pb : 0.0÷51.0(BAR) - 50.0÷150.0(°C) 0÷750(Psi) - 58÷302(°F)
AOM	4	4	4	4	Pr2	Minimum value for analog output	4 ÷ 20
SAO	4	4	4	4	Pr2	Percentage of analog output in case of probe failure	0 ÷ 100 (%)
tbA	yES	yES	yES	yES	Pr2	Alarm relay silencing	no(0) - yES(1)
OAP	cL	cL	cL	cL	Pr2	Alarm relay output polarity	cL ÷ oP
oFF	no	no	no	no	Pr2	Switching ON/OFF enabling from keyboard	no(0) - yES(1)
Ad1	1	1	1	1	Pr2	Compressors address	1 ÷ 247
Ad2	1	1	1	1	Pr2	Fans address	1 ÷ 247
rEL					Pr1	Software release	read only
Ptb					Pr1	Parameter table code	read only
Pr2					Pr1	Protected parameter menu	read only

dixell S.p.a.

Z.I. Via dell'Industria, 27 - 32010 Pieve d'Alpago (BL) ITALY
tel. +39 - 0437 - 98 33 - fax +39 - 0437 - 98 93 13
<http://www.dixell.com> E-mail: dixell@dixell.com